

**MUTOH**

# XPJ-1462UF

## Operation Manual

Operations and Maintenance Methods

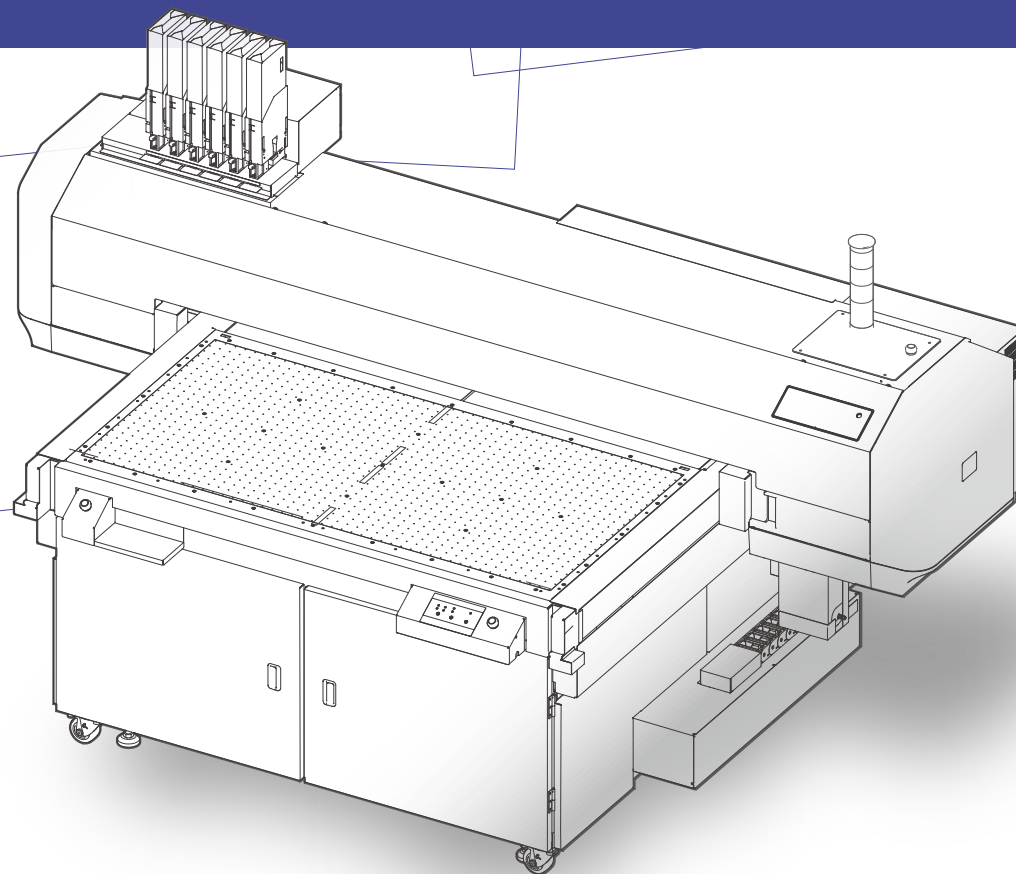

## Important Notice

---

### For Users in Europe

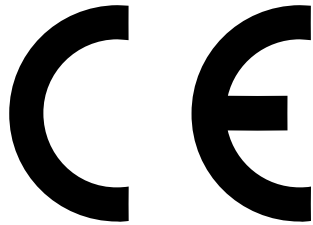

The CE marking is a mandatory European marking for certain product groups to indicate conformity with the essential health and safety requirements set out in European Directives.

By affixing the CE marking, the manufacturer, his authorized

representative, or the person placing the product on the market or putting it into service ensures that the item meets all the essential requirements of all applicable EU directives and that the applicable conformity assessment procedures have been applied.

### For Users in the United States

This equipment has been tested and found to comply with the limits for a Class A digital device, pursuant to Part 15 of the FCC Rules. These limits are designed to provide reasonable protection against harmful interference when the equipment is operated in a commercial environment. This equipment generates, uses, and can radiate radio frequency energy and, if not installed and used in accordance with the instruction manual, may cause harmful interference to radio communications.

Operation of this equipment in a residential area is likely to cause harmful interference in which case the user will be required to correct the interference at his own expense.

This system (including the housing and safety device) is a Class 2 laser product.

Laser specifications of this system (including the housing)  
Wavelength: 655 nm, maximum output: 1 mW or less, pulse duration: 3  $\mu$ s

- Complies with IEC 60825-1 Edition 3.0 (2014-05-15). Complies with FDA performance standards for laser products except for deviations pursuant to Laser notice No.56 dated May 8, 2019.

### CAUTION

Use of controls or adjustments or performance of procedures other than those specified herein may result in radiation exposure.

---

Microsoft® and Windows® are either registered trademarks or trademarks of Microsoft Corporation in the United States and/or other countries.

VerteLith™ is trademark of MUTOH INDUSTRIES LTD.

Company names and product names that appear in this Guide are registered trademarks or trademarks of the respective companies.

- 
- Unauthorized copying or duplication of the whole or part of the contents of this Guide is prohibited.
  - Every care has been taken in writing the contents of this Guide, but please contact MUTOH or the dealer you purchased the product from if you find any unclear, erroneous or otherwise unsatisfactory content in the Guide.
  - Please be aware that MUTOH will not be liable in any way for failures or accidents that result from handling or operating the printer according to any procedures other than those set forth in this Guide.

# Table of Contents

## For Safe Use

7

Safety Precautions .....	8
Restrictions.....	8
Symbols.....	9
Electrical shock hazard / Fire hazard .....	10
Installation .....	12
Handling .....	13
Ink and waste fluid.....	15
Other possible risks.....	17
Warning labels.....	20
Instruction Labels.....	25
Leveling adjusters .....	26

## Before Use

27

Printer main components / Functions.....	28
Front view.....	28
Rear view.....	30
Carriage.....	31
Printer control panel.....	32
Direct keys .....	34

Ink level indicator on the printer control panel.....	36
Vacuum control panel .....	38
How to operate vacuum control panel.....	39

Vacuum table dimensions.....	42
------------------------------	----

Supported media .....	43
-----------------------	----

Media size.....	43
Media handling cautions.....	43
Load media correctly .....	44

Important Notes for using this product .....	45
--	----

Do not power off the printer .....	45
Please use this printer regularly .....	45
Please conduct maintenance regularly .....	45
Some parts need to be replaced periodically.....	46
Use the product in a place that meets "Environmental Requirements".....	46

Connecting to a computer .....	47
--------------------------------	----

System configurations of this product .....	51
---	----

## Setup

52

Turning on the printer.....	53
-----------------------------	----

Turn on the printer.....	53
--------------------------	----

## Table of Contents

Turn off the printer .....	54
<b>Setting up your printer .....</b>	<b>56</b>
Configure the initial settings .....	57
Activate the printer .....	60
Perform initial cleaning to initial ink charging .....	62
Load media .....	72
Run a nozzle check and cleaning .....	78
Perform print head and bidirectional calibrations .....	85
<b>Installing MUTOH Status Monitor .....</b>	<b>93</b>
Installing procedure .....	93
<b>Launching/ Opening/ Exiting MSM .....</b>	<b>94</b>
Launch MSM .....	94
Open MSM .....	94
Open remote panel .....	95
Exit MSM .....	95
MiniMSM .....	96
<b>Installing VerteLith .....</b>	<b>97</b>
<hr/>	
<b>Various Settings .....</b>	<b>98</b>
Key operation .....	99
Print settings menu .....	100
User Type .....	107
Adjust Layer Print .....	108
Select Nozzle .....	113
Automatic nozzle checking .....	116
<b>Test Print menu .....</b>	<b>118</b>
Gantry feed adjustment (PF Adjust) .....	122
<b>Maintenance menu .....</b>	<b>126</b>
UV Scan .....	128
<b>Printer Status menu .....</b>	<b>129</b>
<b>System Information menu .....</b>	<b>130</b>
<b>Ink Agitation menu .....</b>	<b>131</b>
<b>Sleep Mode menu .....</b>	<b>132</b>
<hr/>	
<b>Basic Operations .....</b>	<b>133</b>
<b>Printing .....</b>	<b>134</b>
Printable area .....	134
Printing workflow .....	135
Start printing .....	136
Pause / Resume / Cancel a print job .....	141
Pause / Resume printing .....	142
Cancel printing .....	143
Displaying the time until the next time ink agitation is required .....	144

## Table of Contents

Sleep Mode.....	145
Sleep mode flow.....	145
To wake up from sleep mode.....	146
Stop the printer for emergency.....	147
Location of emergency stop button.....	147

## Advanced Operations 150

Layer printing.....	151
Single-pass layer printing.....	151
Multi-pass layer printing.....	153
Multi-pass layer printing with nesting.....	156
Jig layout printing.....	160
Printing procedure using jig layout.....	161
Simple jig.....	166

## Maintenance 169

About Maintenance.....	170
Wearing protective equipment.....	171
How to wear the supplied gloves.....	171
Agitating ink.....	172
Ink agitation procedure.....	173

Ink agitation procedure.....	179
Checking ink level and replacing ink.....	181
Check the ink level.....	181
When an ink bag is nearing replacement.....	182
Replace with a new ink bag.....	183
Ink replacement procedure.....	183
Replace the adapter's plug for high-capacity ink pack adapter.....	188
Empty the waste ink tank.....	189
Daily maintenance at the end of work.....	193
Daily maintenance flow.....	194
Preparations for daily maintenance.....	195
Perform a daily maintenance.....	197
Printer maintenance.....	204
Head cleaning.....	204
Soak Cleaning.....	206
Cleaning each part of the printer.....	209
Cleaning flow.....	209
Maintenance for optional ionizer.....	211
Replacing consumable parts.....	218
Replacement flow.....	219
Replace the flushing box pad.....	220
Replace the cleaning wiper.....	224
Replace the emitting window glass of the UV-LED lamp.....	227
Replace the filter of UV-LED lamp.....	230

## Table of Contents

Replacing and cleaning the exhaust fan filter .....	232
<b>When not using the printer for a long period of time ..</b>	<b>236</b>
1. Perform a daily maintenance.....	236
2. Flush ink out of printer.....	237
3. Skip daily maintenance and power off the printer .....	238
Initial ink charging after flushing ink out of the printer .....	239
<b>Moving or transporting printer .....</b>	<b>240</b>

## **When problems occur** 241

<b>Messages and Error Messages .....</b>	<b>242</b>
Status messages .....	242
Error message and possible solutions.....	244
Error requiring restart.....	250
<b>Troubleshooting .....</b>	<b>251</b>
Installation/ initial setup-related trouble.....	251
Printer operation-related trouble.....	252
Media-related trouble.....	253
Printing-related trouble.....	255

## **Appendix** 260

<b>Specifications.....</b>	<b>261</b>
----------------------------	------------

<b>Optional accessories / Consumable supplies .....</b>	<b>263</b>
<b>Revision history.....</b>	<b>264</b>

# For Safe Use

# Safety Precautions

## Restrictions

### Trained operator only

Parts of this product has following risks :

- hot surface
- moving parts that can be dangerous if a part of the body gets caught
- emits UV light hazardous to human health

Only operators who have received adequate training by MUTOH or by trained operator are allowed to operate this product.

### Limited access area

- The access to the following area is restricted to an operator who has received adequate training by MUTOH and by trained operator.
- This product must be installed in a room or the area surrounded by fence or partition where only properly trained operators can enter.

#### Restricted area

a= 1000 mm

b= 1000 mm

c= 1000 mm

d= 1000 mm

e= 2000 mm

\*e: Required height for fence

#### ⚠ Cation

⊘ Do not place any objects on the floor of the area shown in the diagonal lines. It may get hit by the gantry.

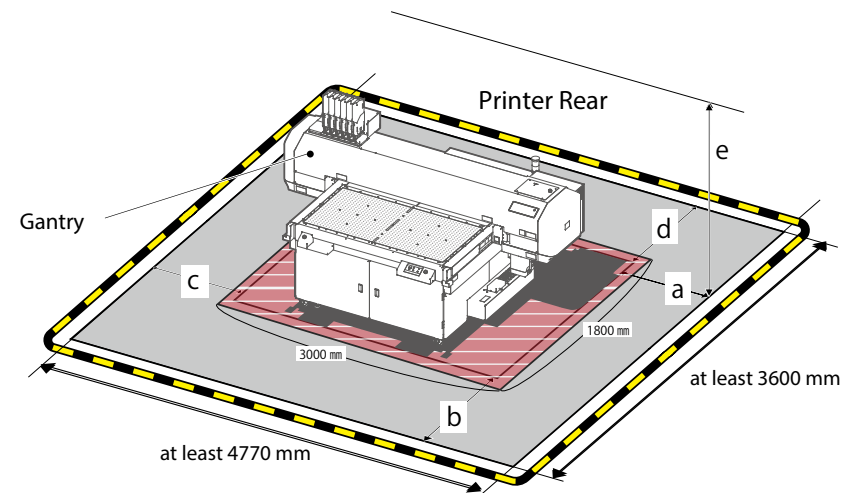



## Symbols



In this document, the following symbols are used for the instructions that must be followed to avoid risk of harm to human health or damage to the property.

Please read and understand the meaning of each symbol and ensure the proper use of the printer.



### ■ Warnings and cautions

 <b>Warning</b>	Failure to follow the instructions could result in serious injury or death.
 <b>Caution</b>	Failure to follow the instructions could result in minor injury or damage to the product.

### ■ Actions that must be avoided or instructions that must be followed

	Indicates an action that must be avoided. A black symbol in the sign indicates the prohibited action.
	Indicates an important instruction that must be followed. A symbol in the sign indicates the instruction must be followed.

### ■ Other symbols

 <b>Important !</b>	Provides information that require special attention or should be followed.
 <b>Note</b>	Provides supplemental or reference information.
	Indicates the link to the reference section.









### **Note**

For the name of each part marked with warning or caution symbols, see "Before Use" on the XPJ-1642UF operation manual.

Safety Precautions

## Electrical shock hazard / Fire hazard

 **Warning**

	<p><b>Do not install this product in a location with high humidity and dust.</b> This could result in an electrical shock or fire.</p>		<p><b>Make sure to use a designated power socket.</b></p>
	<p><b>Do not use a damaged power cord.</b> This could result in an electrical shock or fire.</p>		<p><b>Plug the power cord into the wall outlet.</b> Do not use power strips. This could result in fire.</p>
	<p><b>Do not connect or disconnect the power plug with wet hands.</b> This could result in an electrical shock.</p>		<p><b>Plug the power cords into the wall outlet that has the earth connection and make sure to connect the earth.</b> If the earth is not connected, an electrical shock or fire may occur.</p>
	<p><b>Do not connect an earth wire to the following places:</b></p> <ul style="list-style-type: none"> <li>• <b>Gas pipe</b> It has potential risks of fire and explosion.</li> <li>• <b>Earth wire of telephone cables or lighting rods</b> Large current may flow when the lightning strikes.</li> <li>• <b>Water pipe or faucet</b> It may not work properly if a plastic pipe is connected to the pipe.</li> </ul>		<p><b>Make sure to connect an earth wire to the earth connection that meets the following requirements:</b></p> <ul style="list-style-type: none"> <li>• <b>Earth terminal of power socket.</b></li> <li>• <b>An earth wire with a copper plate which is buried at 650 mm or more in the ground.</b></li> </ul>
			<p><b>Keep ink away from fire or heat source and store in a cool, dark place in order to avoid risk of fire.</b></p>

## For Safe Use

Before Use

Setup

Various Settings

Basic Operations









Advanced Operations

Maintenance

When problems occur

Appendix





### Safety Precautions

	<p><b>Do not insert or drop metal or flammable objects into the printer through openings such as vent.</b> This could result in an electrical shock or fire.</p>		<p>Be sure to use the designated power cords.</p> <ul style="list-style-type: none"> <li>• Failure to do so could result in an electrical shock or fire. For the designated power cord, please contact your local MUTOH dealer.</li> <li>• The power cord should have the protective ground terminal and make sure to plug in securely.</li> <li>• Use the power cords which meet the safety standard, voltage and plug shape of the country to use this product.</li> </ul>
	<p><b>Do not block the vent on the product with cloth or other materials.</b> If covered, the inside the product gets hot, resulting in fire.</p>		
	<p><b>Never open the covers securing with screws.</b> This could result in an electrical shock or damage to the printer.</p>		
	<p><b>Ensure that no moisture enters the product.</b> This could result in an electrical short circuit.</p>		<p><b>Make sure to follow the instructions on this guide to connect the power cord or cables.</b> Failure to do so could result in fire.</p>
	<p><b>If foreign objects or liquid accidentally entered the inside the product, do not use the printer.</b> This could result in an electrical shock or fire. Immediately power off the printer and disconnect the power plug from the outlet. Then contact the MUTOH customer support.</p>		
	<p><b>Follow the precautions below when handling the power cord.</b></p> <ul style="list-style-type: none"> <li>• Do not modify power cords.</li> <li>• Do not place heavy objects on power cords.</li> <li>• Do not bend, twist, or pull on power cords.</li> <li>• Do not route power cords near heating equipment.</li> </ul>		<p><b>Follow the precautions below when handling the power plug.</b></p> <ul style="list-style-type: none"> <li>• Do not allow dust or foreign objects to accumulate around the power plug.</li> <li>• Firmly insert the power plug into the wall outlet.</li> </ul>



Safety Precautions

## Installation

### Warning

	<p>Choose the location which satisfies the requirements below:</p> <ul style="list-style-type: none"> <li>• The floor must be level.</li> <li>• Avoid vibration from the neighboring devices.</li> <li>• Low humidity and free from dust.</li> <li>• Less chance of temperature and humidity changes.</li> <li>• Avoid direct sunlight.</li> <li>• Avoid water.</li> <li>• Avoid direct air onto the printer.</li> <li>• Low levels of electromagnetic waves.</li> </ul>		<p><b>Keep the work area well-ventilated.</b> Odor of UV ink could have adversely impact on health. If you experience headache, fatigue or dizziness, stop your work and immediately get to fresh air. If nausea persists, seek medical advice.</p>
	<p>This equipment is not suitable for use in locations where children are likely to be present.</p>		<p>The floor where the product is installed must be able to support heavy loads. The weight of this product will be over 500 kg (including jig, ink, waste ink, media)</p>









### Caution

	<p>Next to the UV-LED lamp in the printer, there may be other sources of UV light present in the working environment: sunlight or any form of artificial light. To avoid printer damage (nozzle clogs, operation faults to the maintenance station, print head damage.) caused by unintentional curing by UV light sources present in the working area, please follow these guidelines:</p> <ul style="list-style-type: none"> <li>• Do not install the product in direct sunlight. Make sure to keep the front cover closed unless necessary to open it.</li> <li>• Do not remove the cover. Do not modify this product. The warranty does not cover if the product has been modified or disassembled.</li> </ul>		
	<p>Minimum three people are required for moving this product. When moving, keep this product level.</p>		<p><b>Do not tilt or turn the product upside down.</b> The ink inside the printer may spill. MUTOH cannot guarantee that the printer can run properly.</p>





Safety Precautions

## Handling

### Warning

    	<ul style="list-style-type: none"> <li>• While the printer is in operation, make sure to wear UV protective glasses, mask, gloves and protective clothing, and follow these instructions:</li> <li>• Do not stare at the UV-LED lamp. This may cause damage to eyes.</li> <li>• Avoid direct skin exposure to UV light. This may cause inflammation.</li> </ul>	 Do not sit on or place heavy objects on the product. Failure to do so may result in injury from a fall.
		 Do not touch the moving parts. This may cause injury or damage to the product.
	 In case you need to move the printer after ink was filled, move it slowly to avoid impact and risk of ink leakage.	 Do not sit on the vacuum table. This could deform the table.

### Caution

    	<p>When cleaning, follow these precautions:</p> <ul style="list-style-type: none"> <li>• Make sure to wear protective equipment (gloves, goggles or eye protection, protective clothing, mask).</li> <li>• Always follow the steps to perform maintenance. When moistening the surface of nozzles, do not use the cleaning stick already used to clean around the print head, the cleaning wiper or around the capping unit. Doing so may result in damage to the print head.</li> <li>• Always use a new cleaning stick and dampen it with designated maintenance cleaner. Do not use other type of maintenance cleaner. It may cause nozzle clogging.</li> <li>• Do not touch the tip of a cleaning stick with fingers. If finger oil gets on the stick, it will damage the print head.</li> <li>• Do not reuse a cleaning stick. Dust sticking to the stick will cause damage to the print head.</li> </ul>
--	--

## For Safe Use

Before Use

Setup

Various Settings

Basic Operations











Advanced Operations

Maintenance

When problems occur

Appendix

### Safety Precautions

	<p>Never touch the print head nozzles when cleaning around the print head. This could damage the print head.</p>		<p>Do not touch the cleaning wiper and the print head capping station with bare hands when cleaning the wiper. If finger oil gets on this, head cleaning cannot be performed properly.</p>
	<p>Before moving this printer, always empty the waste ink tank even moving short distance. Failure to do so may result in damage to the product.</p>		<p>Do not use volatile chemicals such as thinner, benzene or alcohol for cleaning. This will damage the paint on the printer.</p>
	<p>When handling the front cover or the maintenance cover, always use the following safety precautions:</p> <ul style="list-style-type: none"> <li>• Avoid strong airflow from a fan or an air conditioner to install this printer.</li> <li>• If not, it may accidentally close the cover.</li> <li>• When opening the cover, make sure the cover does not hit anyone or anything.</li> </ul>		<p>When loading a new media, make sure to place it on an appropriate position and input correct media information. If wrong information is entered, the printer can print on an unintended position on the table. UV ink sticking on the table will be cured by UV lamp and will not be removed from the table.</p>
 	<p>Make sure the print is completely cured before touching. If you are not sure, wear gloves to avoid skin or clothing contact with ink.</p>		<p>Do not attempt the following actions during ink charging:</p> <ul style="list-style-type: none"> <li>• Power off the printer.</li> <li>• Disconnect the power cord.</li> <li>• Open the front cover or the maintenance cover.</li> <li>• Move the printer.</li> </ul>
	<p>Do not place any objects on the floor within the gantry moving range. The gantry will hit it, leading to damage to the product.</p>		

Before Use

Setup

Various Settings

Basic Operations

Advanced Operations

Maintenance







When problems occur

Appendix

Safety Precautions

## Ink and waste fluid

### Warning

	The safety concerns involved with using and handling of UV curable ink and waste fluid are detailed in the Safety Data Sheets (SDS). Please carefully read these sheets before handling these liquids.
	Store ink bags and waste fluids in a cool, dark place and avoid direct sunlight. Keep away from <ul style="list-style-type: none"> <li>• children's reach</li> <li>• fire and heat</li> </ul>
    	<p>Wear protective equipment (gloves, goggles or eye protection, protective mask, protective clothing) when handling ink.</p> <ul style="list-style-type: none"> <li>• Do not touch uncured UV ink with bare hands. UV ink curing time varies depending on surface characteristics of media. Especially a print with low ink coverage needs to rest for a while (approximately one hour). When checking that it is cured, make sure to wear protective gloves.</li> <li>• Especially during operations where ink might contact you (e.g. handling ink or waste fluid, cleaning of print head/cap/wiper), always wear protective equipment (such as solvent-resistant gloves and goggles) to avoid contact with skin or eyes.</li> <li>• Two types of gloves are supplied with the printer. To avoid ink penetration, please wear rubber gloves (white) over polyethylene gloves (pink). If these gloves are not available, butyl rubber gloves are recommended.</li> <li>• If glove becomes contaminated with ink, replace with new ones.</li> <li>• If ink gets on skin, immediately wash with soap and plenty of water for 15minutes. Seek medical advice/attention if irritation or inflammation are present.</li> <li>• If ink gets in eyes, flush eyes with plenty of water for 15minutes and seek medical advice/attention immediately.</li> <li>• If swallowed, rinse mouth immediately and do not induce vomiting. Seek medical advice/attention.</li> </ul>

## For Safe Use

Before Use

Safety Precautions

Setup

Various Settings

Basic Operations

Advanced Operations

Maintenance

When problems occur

Appendix



- You are obligated to properly dispose of ink and ink and waste fluid collected collected from the printer in compliance with Wastes Disposal and Public Cleansing Act and local ordinances.  
Delegate disposal to an industrial waste disposal contractor.
- Waste fluid from this printer is harmful to aquatic organisms. Do not allow it to reach sewage or natural water systems.
- Use a HDPE container with light blocking properties to store waste liquid.
- When storing waste fluid for a long time, slightly loosen the cap on the container to allow air. Do not tightly close it.
- Do not mix waste ink with any other chemical substances, not even in small amounts.  
When mixed with other chemicals (e.g. oxidants), heating may occur.

### Caution

	<p>Follow these precautions when handling ink bag:</p> <ul style="list-style-type: none"> <li>• Do not disassemble</li> <li>• Do not drop or hit</li> </ul> <p>This could lead to ink leakage.</p>		<p>Use of non-designated ink could cause printer failure. Mutoh does not cover the cost of repair caused by such use.</p>
	<p>Follow these instructions when handling ink bags:</p> <ul style="list-style-type: none"> <li>• Let an ink bag rest in the work area for at least 3 hours to warm up to room temperature before use.</li> <li>• Agitate ink by ink bag inversion before loading it in the printer. Agitate ink in an ink bag when the message prompted on the control panel.</li> </ul>		
	<p>Use inks within its shelf life.</p> <ul style="list-style-type: none"> <li>• Using an expired ink could result in damage to the printer.</li> <li>• When expired, replace with a new one even if ink remains in the ink bag.</li> <li>• Dispose of expired ink as industrial waste. Put the emptied ink bag in a plastic bag and dispose of it according to the local regulations.</li> </ul>		
	<p>MUTOH recommends you to use genuine ink. This printer is designed to deliver best performance by using MUTOH genuine ink. The use of non-genuine ink may affect the printer as well as print quality. This is not covered by the warranty.</p>		

## For Safe Use

Before Use

Safety Precautions

Setup

Various Settings

Basic Operations

Advanced Operations

Maintenance

When problems occur

Appendix

## Other possible risks

The following danger may occur.

Never put hands between the gantry and the top surface of the vacuum table.

- Your hands may get caught and injured.



Never put hands between the gantry and the side surface of the vacuum table.

- Your hands may get caught and injured.



## For Safe Use

Before Use

Safety Precautions

Setup

Various Settings

Basic Operations

Advanced Operations

Maintenance

When problems occur

Appendix

Do not insert any object or put hands or face closer to the cable drag chain.  
• Your hands may get trapped and injured.

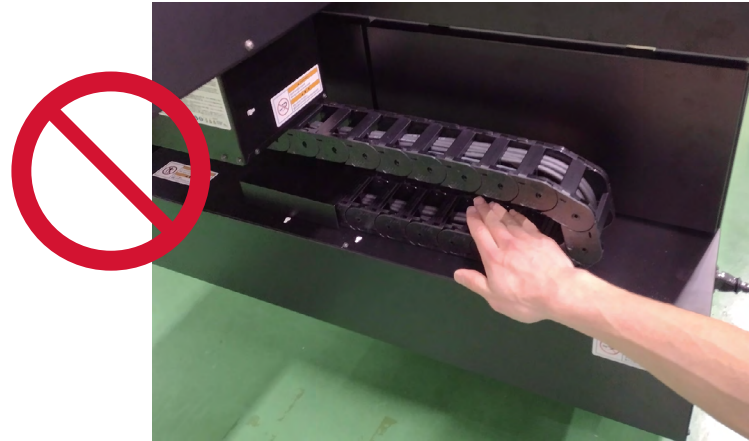

Keep away from the area that the gantry moves while printer is in operation.  
• Parts of the body may be crushed and get injured.



## For Safe Use

Before Use

Safety Precautions

Setup

Various Settings

Basic Operations

Advanced Operations

Maintenance

When problems occur

Appendix

Do not look directly at UV light and touch around the UV-LED lamp.

- Wear UV protective glasses when operating this printer.
- When you sit on a chair while operating, make sure the vacuum table is not positioned at eye level. This is the height you will get most UV exposure from this product. Never look directly at UV light.
- Do not touch around the UV-LED lamp. It gets hot and you may get burn injury.



## For Safe Use

Before Use

Setup

Various Settings

Basic Operations

Advanced Operations

Maintenance

When problems occur

Appendix

### Safety Precautions

## Warning labels

Warning labels are affixed to the hazardous area of the printer. Read and follow the instructions on the labels.

In case the warning labels came off or get dirty, please contact your local MUTOH dealer for replacement.

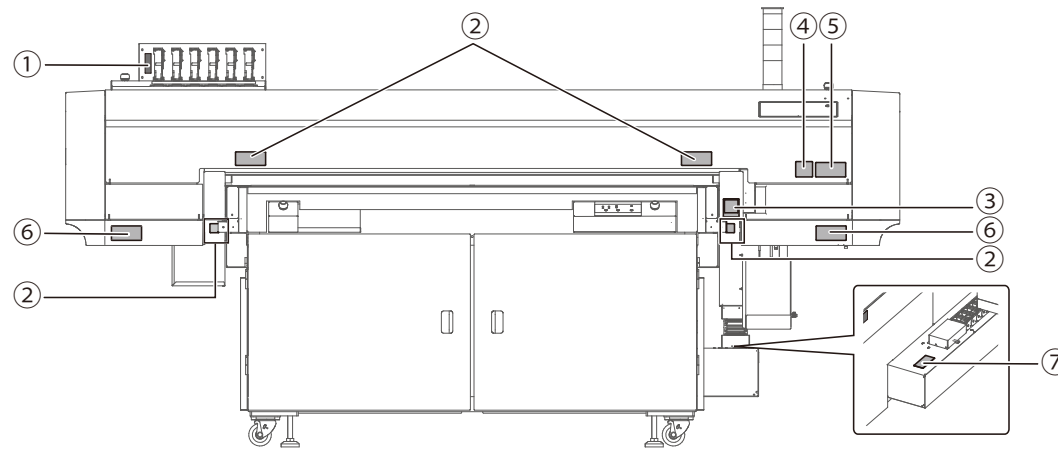

Printer Front

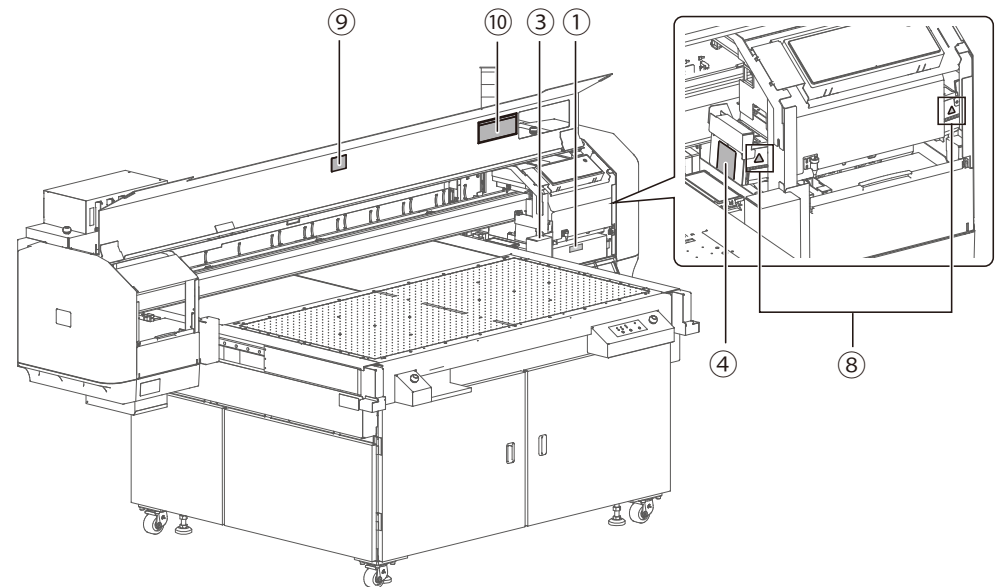

## For Safe Use

Before Use

Setup

Various Settings

Basic Operations

Advanced Operations

Maintenance

When problems occur

Appendix

### Safety Precautions

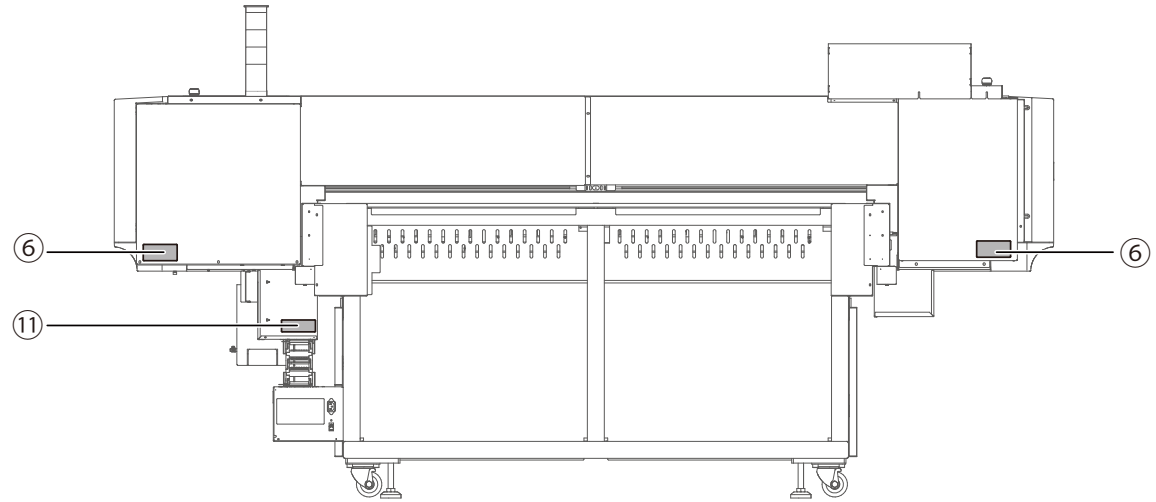

Printer Rear

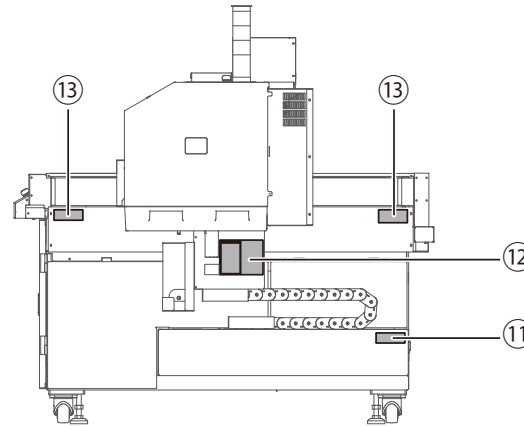

Right Side

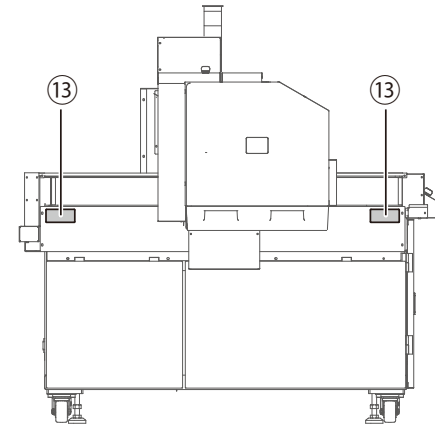

Left Side

\*With gantry in the center position

## For Safe Use

Before Use

Safety Precautions

Setup

Various Settings

Basic Operations

Advanced Operations

Maintenance

When problems occur

Appendix

### Type of labels

### Name / Meaning

①



#### Personal Protective Equipment Label

- Wear necessary protective equipment when handling ink.

②



#### Pinch Point Hazard Label

- Keep hands clear.
- Do not put your hands in the gap between the gantry and the table or put your hands on or into the moving parts.

③

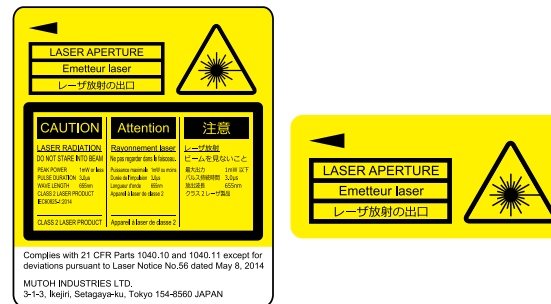

#### Laser Safety Label

- Laser radiation: Do not stare into beam.

④

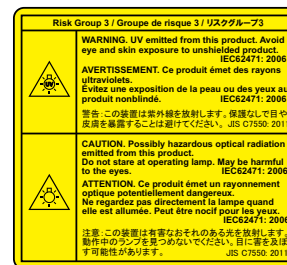

#### UV Safety Label

- UV light hazard: Avoid direct skin or eye exposure to light.

## For Safe Use

Before Use

Setup

Various Settings

Basic Operations

Advanced Operations

Maintenance

When problems occur

Appendix

## Safety Precautions

⑤



### UV Protective Equipment

- Wear UV protective goggles, long sleeves and long pants while operating printer.

⑥

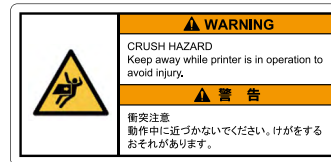

### Crush Hazard

- Risk of crush injury. Keep away while printer is in operation.

⑦



### Do Not Step On

- Do not step on this surface. This may cause injury from falling or damage to the printer.

⑧



### Hot Surface Hazard Label

- Risk of burns. Do not touch this surface for 10 minutes after printing.

⑨

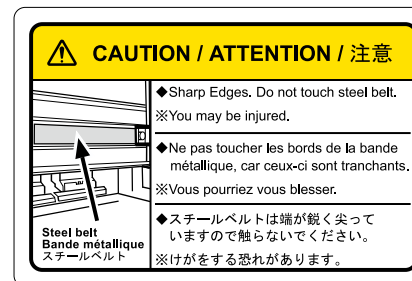

### Steel Belt Caution

- Do not touch this part to avoid injury.

## For Safe Use

Before Use

Setup

Various Settings

Basic Operations

Advanced Operations

Maintenance

When problems occur

Appendix

## Safety Precautions

⑩

**CAUTION / ATTENTION / 注意**

● Avoid air from fan or air conditioner blowing directly on the printer.  
This will dry the ink in the head nozzles causing clogging that affects ink jetting, and you will not be able to obtain satisfactory printing results.  
● Do "Warm" cleaning once a week if the printer is not used for a long period.  
Without cleaning the ink will dry inside the nozzle, causing damage to the print head.  
● The following actions must be avoided while printing: Opening the front cover, Touching media, Inserting your hands into the opening in the printer. This may cause injury or lead to poor print results.

● Ne pas exposer directement l'imprimante aux courants d'air des appareils de ventilation ou de climatisation.  
Un courant d'air peut affecter la tête d'impression d'une qualité d'impression satisfaisante, ou entraîner un dysfonctionnement de la tête d'impression, suite à l'assèchement de l'encre à l'intérieur des buses.  
● En cas d'inactivité par l'imprimante durant une longue période, effectuez un nettoyage normal une fois par semaine.  
Sans vous ne la faites pas, cela pourrait entraîner un dysfonctionnement de la tête d'impression, suite à l'assèchement de l'encre à l'intérieur des buses.  
● Évitez de passer la main par l'ouverture de l'impression. De plus, en cours d'impression, ne pas introduire vos mains par le couvercle avant, et ne pas toucher au papier. Vous pourriez vous blesser, ou ne pas obtenir une qualité d'impression satisfaisante.

● 印刷中に乾燥や空調の風を当てて下さい。  
乾燥によりインクヘッドのノズルが詰まり、インクが正常に噴射できなくなり、インクの吐出に影響が与えられることがあります。  
● 長期印刷を行わない場合は、週一回「ウォームクリーニング」を行ってください。  
ウォームクリーニングを行わずに放置すると、インクがノズル内部で乾燥し、ノズルが破損の原因になります。  
● 印刷中はフロントカバーを開けしないでください。また、印刷中は開口部から手を入れたり印刷中に触れないでください。思わぬケガをしたり、良好な印刷結果が得られないことがあります。

## Front Cover Caution

- Follow the instructions on this label.

⑪

**WARNING**

KEEP HANDS CLEAR  
Moving parts can cause injury.

**警告**

手を入れしないでください。  
巻き込まれてけがをすることがあります。

## Keep Hands Clear

- Do not touch or put your hands or face closer to this part.  
Your body part may get trapped between the moving parts.

⑫

**CAUTION / ATTENTION / 注意**

Waste ink has following negative effects on human health. Wear protective mask, glasses, gloves, and dothing when handling.  
● Before using this product, be sure to read the Safety Data Sheet (SDS)  
● Harmful if swallowed or gets on skin.  
● Cause serious eye damage if gets in eyes.  
● Cause blood or systemic toxicity, or damage to central nerve system.  
● May cause allergic skin reaction or respiratory irritation, or may damage fertility or the unborn child.  
● May cause damage to blood or kidney through prolonged or repeated exposure.  
● The workbao should be free from open flame and well ventilated.  
● Handle the ink with care to avoid the ink touch to your skin eyes and clothing, also to avoid accidental ingestion. Be careful not to inhale the vapor.  
● Contaminated clothing should be thoroughly cleaned.  
● Wash your hands and gargle well after using.

Les résidus d'encre ont les effets négatifs suivants sur la santé humaine. Porter un masque, des lunettes, des gants et des vêtements de protection lors de la manipulation.  
● Avant utilisation de ce produit, lisez sa fiche de données de sécurité (SDS)  
● Nocif en cas d'ingestion ou de pénétration cutanée.  
● Cause des lésions oculaires graves en cas de pénétration dans les yeux.  
● Provoque une toxicité sanguine ou systémique, ou des dommages au système reproducteur central.  
● Peut provoquer une réaction allergique de la peau ou une irritation des voies respiratoires, ou peut nuire à la fertilité ou au fœtus.  
● Peut provoquer des lésions sanguines ou rénales à la suite d'expositions répétées ou d'une exposition prolongée.  
● Veuillez travailler dans un lieu bien ventilé et sans flamme ouverte.  
● Manipulez l'encre avec précaution, afin qu'il n'entre pas en contact avec la peau, les yeux ou les vêtements, et d'éviter toute ingestion accidentelle.  
● Prenez également garde à ne pas inhaler les vapeurs d'encre.  
● Les habits de travail tachés par l'encre doivent être bien nettoyés.  
● Après manipulation, bien vous laver les mains et vous rincer la bouche avec soin.

● 廃インクは人々への以下のような影響があります。取扱中は保護マスク、保護メガネ、保護手袋、保護衣を着用してください。  
● 使用前に、必ず安全データシート（SDS）をお読みください。  
● 誤飲や目への接触は有害です。  
● 目に入ると重篤な眼の損傷となります。  
● 皮膚や目への接触は有害です。  
● アレルギー性皮膚反応、呼吸器への刺激、生殖への悪影響のおそれがあります。  
● 長期または反復曝露により血液、腎臓への被害のおそれがあります。  
● インクを扱う際は、インクが肌や目、衣服に接触しないよう、また誤飲や吸入を避けてください。蒸気も吸入しないよう十分に注意して取扱ってください。  
● 汚染された衣服は、その汚れをよく落とす必要があります。  
● 取り扱い後は、手洗いと口すすぎが十分にしてください。

**Emergency Measures**  
● If on skin, wash well with plenty of soapy water. Consult your doctor if your skin feels irritated or itchy, discolored.  
● If in eyes, wash well with plenty of tap water and seek medical attention as soon as possible.  
● If accidentally swallowed, do not vomit. Consult your doctor as soon as possible.  
● If inhaled, stop, move to fresh air. Consult your doctor if you experience dizziness or nausea.  
● If breathing has stopped, apply artificial respiration immediately, and call emergency medical assistance.  
● If spilled from the container, remove all sources of heat, ignition and flame, then wipe up with cloth. The contaminated cloth should be soaked in water until disposed.

**Mesures d'urgence**  
● En cas de contact avec la peau, bien laver et rincer abondamment avec de l'eau savonneuse. Consulter un médecin si la peau est irritée ou si vous constatez une modification de son aspect.  
● En cas de contact avec les yeux, rincer abondamment avec de l'eau ou du sérum, et consulter un médecin le plus rapidement possible.  
● Ne pas régurgiter si vous avez ingéré de l'encre par mégarde. Ne pas régurgiter si vous avez ingéré de l'encre par mégarde.  
● En cas d'inhalation de vapeurs, déplacez-vous dans un endroit où l'air est propre, consultez un médecin si vous êtes pris de vertiges ou de nausées.  
● En cas d'échec de la respiration, pratiquer immédiatement une ventilation artificielle et contactez les urgences.  
● Si l'encre a coulé du réservoir, éliminez d'abord des sources de chaleur, des étincelles ou des flammes, puis essuyer avec un morceau de tissu. Toujours laisser tremper les tissus tachés avec de l'encre dans l'eau jusqu'à leur élimination.

**応急処置**  
● 皮膚に付着した場合は多量の石鹸水で洗い流し、皮膚に刺激を感じたり変化がある場合は医師の診察を受け付けてください。  
● 目に入った場合は多量の水道水で洗い流し、出来るだけ早く眼科の診察を受け付けてください。  
● 誤って飲み込んだ場合は吐き出さないでください。その場できるだけ早く（医師の診察を受けて）ください。  
● 吸入した場合は新鮮な空気の清浄な場所に移動し、めまいや吐き気を感じる場合は医師の診察を受け付けてください。  
● 呼吸が止まった場合はたんに人工呼吸を行い、救急処置を受けてください。  
● 容器からこぼれた場合は、熱源、火花、炎から隔離し、布で拭き取ってください。インクがこぼれた布は必ず水を十分に吸収してから処分してください。

## Waste Ink Caution Label

- Avoid direct skin contact with waste ink. If on skin, follow the first aid instructions on the label.

⑬

**WARNING**

Keep body parts away from moving parts to avoid injury.

**警告**

可動部に身体を近づけないでください。  
はさまれてけがをすることがあります。

## Moving Parts Crush Hazard

- Keep body parts away from this area.

## For Safe Use

Before Use

Safety Precautions

Setup

Various Settings

Basic Operations

Advanced Operations

Maintenance

When problems occur

Appendix

## Instruction Labels

Instruction labels are affixed where special attention for operating this product is required. The contents of each label are shown here.

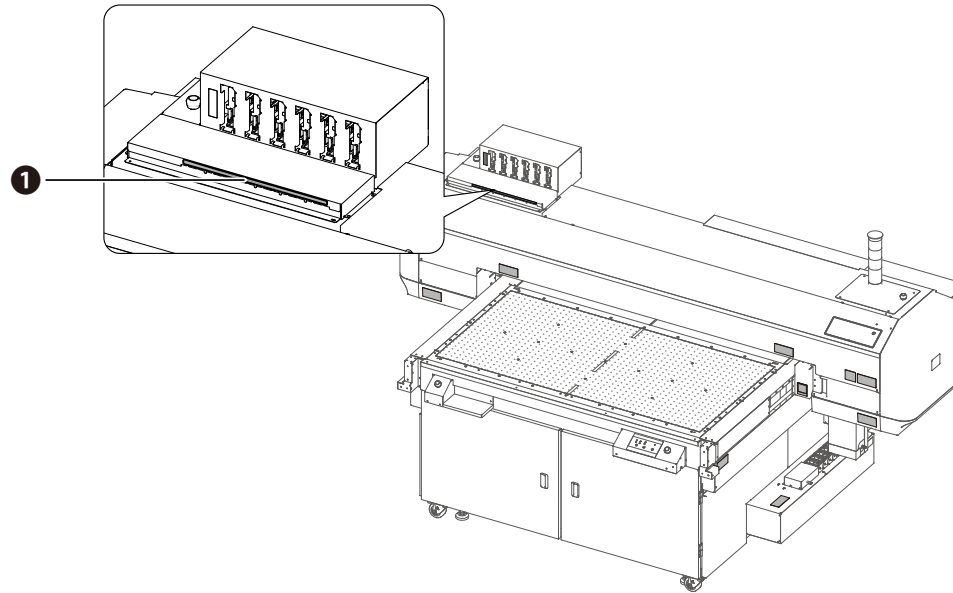

Printer Front

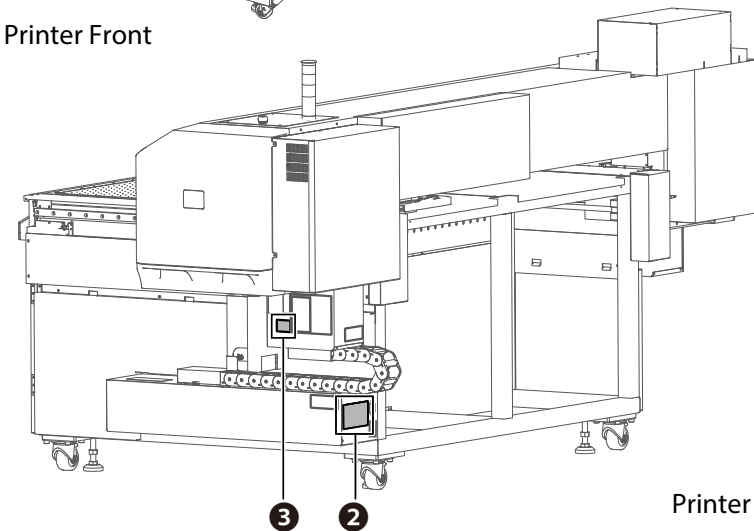

Printer Rear

## For Safe Use

Before Use

Setup

Various Settings

Basic Operations

Advanced Operations

Maintenance

When problems occur

Appendix

## Safety Precautions

### Type of labels

### Name / Meaning

①



#### Ink Color Label

- Make sure to match the color of the ink to the color on this label and insert an ink bag into the correct ink slot.

②

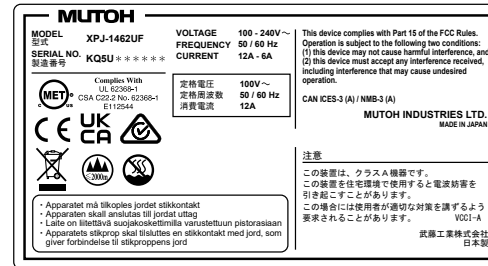

#### Rating Plate

- Rating Plate provides the model number and serial number of the printer.

③

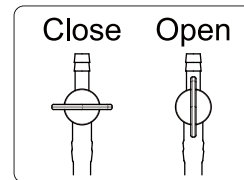

#### Drain Valve Label

- The diagram shows the open or close position of the drain valve.

## Leveling adjusters

Before powering on, make sure to lock the casters of this product using foot adjuster.

If casters are not locked, the printer could move while printing.

For how to adjust, see "Installation" on XPJ-1462UF Startup Guide.

# Before Use

**Printer main components / Functions 28**

**Vacuum table dimensions 42**

**Supported media 43**

**Important Notes for using this product 45**

**Connecting to a computer 47**

**System configurations of this product 51**

Before Use

Setup

Various Settings

Basic Operations

Advanced Operations

Maintenance

When problems occur

Appendix

Printer main components / Functions

Vacuum table dimensions

Supported media

Important Notes for using this product

Connecting to a computer

System configurations of this product

# Printer main components / Functions

## Front view

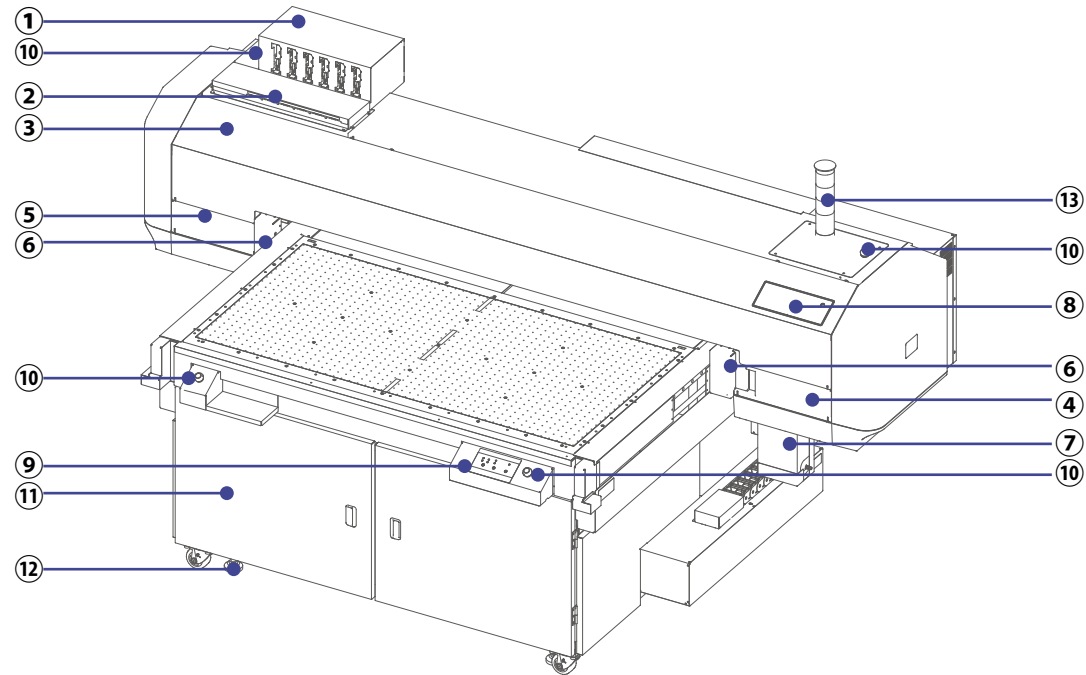

①	Ink slot	Insert an ink bag accommodated in the high-capacity ink pack adapter or a cleaning cartridge into this slot.
②	Card slot	Insert an smartchip card into this slot.
③	Front cover	Open or close the cover for maintenance. Normally it is closed. <div style="border: 1px solid green; padding: 5px; margin-top: 10px;"> <p><b>Important!</b> When closing the front cover, make sure to push the center of the cover.</p> </div>

**Before Use****Setup****Various Settings****Basic Operations****Advanced Operations****Maintenance****When problems occur****Appendix****Printer main components / Functions****Vacuum table dimensions****Supported media****Important Notes for using this product****Connecting to a computer****System configurations of this product**

④	Maintenance cover R	Open or close the cover for maintenance or replacement of consumables parts. Normally it is closed.
⑤	Maintenance cover L	Open or close the cover when printing a Nozzle Check L pattern. Normally it is closed.
⑥	Media height detector	Detects the height of media.
⑦	Waste ink tank	Collects waste fluids from the printer. Empty the tank before it becomes full. ☞ <b>" 2. Drain waste fluid "P.64</b>
⑧	Printer control panel	☞ <b>" Printer control panel "P.32</b>
⑨	Vacuum control panel	☞ <b>" Vacuum control panel "P.38</b>
⑩	Emergency stop button	Push this button in case you need to stop the printer immediately. This printer has four emergency stop buttons; two located on the front left and right of the printer and two located on both ends of the gantry. ☞ <b>" Stop the printer for emergency "P.147</b>
⑪	Light-blocking cabinet	Suitable for storing UV ink.
⑫	Leveling adjuster	☞ <b>" Leveling adjusters "P.26</b>
⑬	Signal tower light	Indicates printer status with three LED lights. It operates simultaneously with the status light on the printer control panel. <ul style="list-style-type: none"> <li>• Ready-to-print status: Solid green</li> <li>• Printer is in operation: Blinking green</li> <li>• Ink is low or expired, Printer is recovering from emergency stop, "Temperature too low" or "Temperature too high" warning message appears: Solid yellow.</li> <li>• Error occurred: Solid red</li> </ul> ☞ <b>" Status light : "P.32</b>

## Before Use

### Setup

### Various Settings

### Basic Operations

### Advanced Operations

### Maintenance

### When problems occur

### Appendix

## Printer main components / Functions

### Vacuum table dimensions

### Supported media

### Important Notes for using this product

### Connecting to a computer

### System configurations of this product

## Rear view

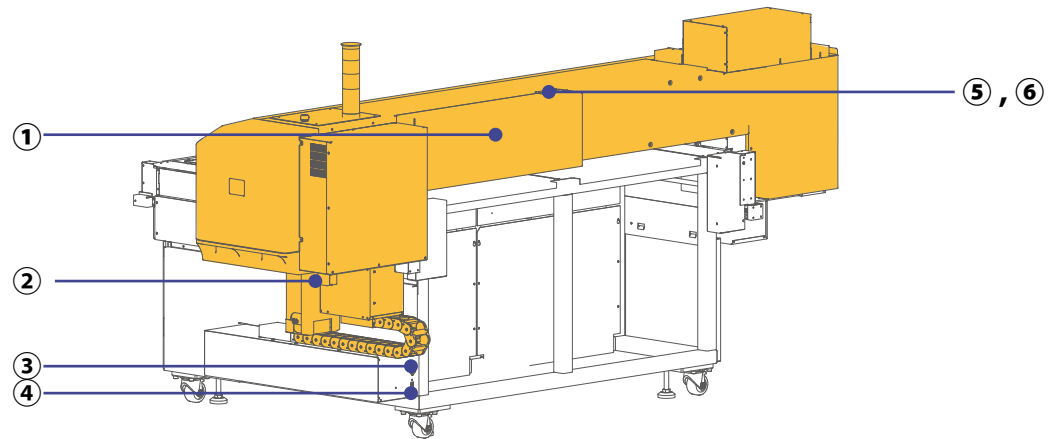

①	Gantry	Moves back and forth on the vacuum table while printing or moves up and down when performing maintenance.
②	Waste ink drain valve case	Stores the waste ink drain valve for emptying the waste ink tank.
③	AC inlet	Connect the power cord.
④	Network connector	Connect the Ethernet cable.
⑤	Exhaust fan	Remove exhaust from inside the printer.
⑥	Exhaust fan filter	Reduce ink mist contamination inside the printer.

## Before Use

### Setup

### Various Settings

### Basic Operations

### Advanced Operations

### Maintenance

### When problems occur

### Appendix

## Printer main components / Functions

Vacuum table dimensions

Supported media

Important Notes for using this product

Connecting to a computer

System configurations of this product

## Carriage

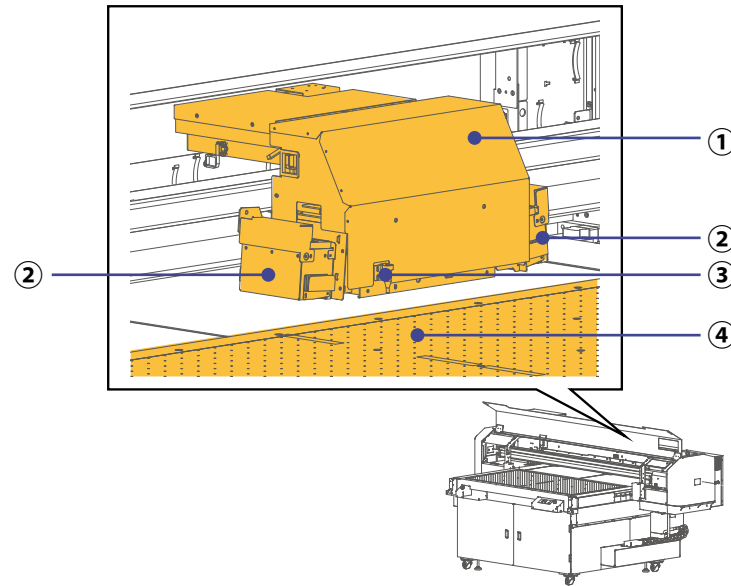

①	Carriage	The print head and the UV-LED lamp are built in.
②	UV-LED lamp	Emits the UV light to cure prints.
③	LED pointer	Use it to see the print start position.
④	Vacuum table	Printing is performed on the vacuum table. The vacuum fan is mounted inside the table.  <a href="#">" Vacuum control panel "P.38 ,"</a> <a href="#">" How to operate vacuum control panel "P.39</a>

## Before Use

### Setup

### Various Settings

### Basic Operations

### Advanced Operations

### Maintenance

### When problems occur

### Appendix

## Printer main components / Functions

Vacuum table dimensions

Supported media

Important Notes for using this product

Connecting to a computer

System configurations of this product

## Printer control panel



### How to operate

The printer control panel is a touch-screen panel. The active keys are lit up on the panel for guidance.



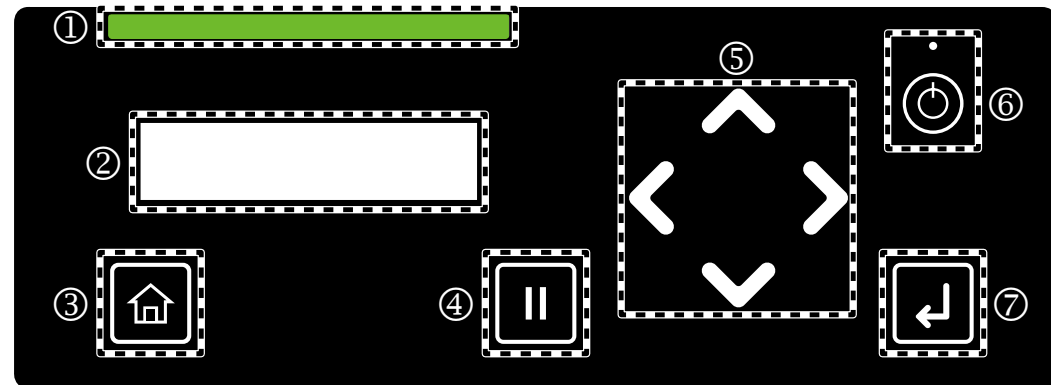









- Tap: Lightly touch and release the key.

### Name of parts / Functions



①	Status light :	Indicates the status of the printer. <ul style="list-style-type: none"><li>• Working normally: Solid green</li><li>• Error state: Solid red</li></ul>
②	Display :	Displays the printer status, setup menu, error messages and so on.
③		[Home] key : Tap to access to or exit the setup menu.
④		[Cancel] key : Tap to pause printing. Tapping the key again will resume printing.

<b>Before Use</b>	<b>Printer main components / Functions</b>
Setup	Vacuum table dimensions
Various Settings	Supported media
Basic Operations	Important Notes for using this product
Advanced Operations	Connecting to a computer
Maintenance	System configurations of this product
When problems occur	
Appendix	

⑤		<p>Arrow keys :</p> <p>In the Setup menu, use these keys to select a menu or enter a value.</p> <ul style="list-style-type: none"> <li>•  key: Scroll up the menu list.</li> <li>•  key: Return to the previous menu without saving the change.</li> <li>•  key: Go to the next level menu.</li> <li>•  key: Scroll down the menu list.</li> </ul> <p>In ready-to-print state, use these keys to remove/load media or perform nozzle check print or cleaning.</p> <ul style="list-style-type: none"> <li>•  key: Tap after loading media to change to the ready-to-print state.</li> <li>•  key: Run a nozzle check print.</li> <li>•  key: Perform a cleaning cycle.</li> <li>•  key: Tap after printing to change to the Remove Media state.</li> </ul>
⑥		<p>Power button</p> <p>Press and hold the button for more than two seconds to turn on the printer. The small LED above the button will turn on white.</p> <p>While the printer is turned on, press and hold the button for more than two seconds to turn off the printer. The LED above the button will turn off.</p> <div data-bbox="1227 898 2101 1106" style="border: 1px solid green; padding: 5px;"> <p> <b>Note</b></p> <p>The  symbol means standby. This printer consumes some power unless the power cord is disconnected. In this document, this state is referred to as the power being "off". The small LED above the Power button turns on when the power cord is plugged into an outlet.</p> </div>
⑦		<p>Enter key</p> <p>Tap to confirm the menu or the value selected.</p> <p>Tapping the [Enter] key while "Print Ready" or "Set media. then Tap [ ^ ] key]" is displayed will move to the menu that you can check the time until the next time ink agitation is required.</p>

## Before Use

## Setup

## Various Settings

## Basic Operations

## Advanced Operations

## Maintenance

## When problems occur

## Appendix

## Printer main components / Functions

Vacuum table dimensions

Supported media

Important Notes for using this product

Connecting to a computer

System configurations of this product

## Direct keys

While the following messages appear on the printer control panel (ready to print state), you can directly access to some of the menus by tapping the following keys.

Print Ready  
H:XXX.Xmm



Set media, then  
Tap [^] key.

### ◀ key

When media is loaded : Tap to access the nozzle check pattern selection menu.

- The message [ Start Printing?/ Nozzle Check F ] appears.
- Use ◀ / ▶ key to select a nozzle check pattern. If nozzle check L is selected, tap ▶ key so that [Nozzle check L/ Start -> Enter] will appear.
- Tapping ⏴ Enter key will print a selected nozzle check pattern.
- By tapping 🏠 Home key, the display will return to [Print Ready].

### 📖 Note

There are four types of nozzle check patterns. 🖱️ "Types of nozzle check patterns" P.78

When media is not loaded : Tap to access the nozzle check L print menu.

- The message [Start Printing?/ Nozzle Check L] appears. Tap ▶ key so that [Nozzle check L/ Start -> Enter] will appear.
- Tapping ⏴ Enter key will print a nozzle check L pattern.
- By tapping 🏠 Home key, the display will return to [Set media. then Tap [ ^ ] key].

### ▶ key





Tap to access to the cleaning start menu.

- The message [Clean Print Head? Short] appears.
- Use ◀ / ▶ key to select a cleaning mode and then tap ⏴ Enter key so that the printer begins cleaning.
- By tapping 🏠 Home key, the display will return to [Print Ready] or [Set media. then Tap [ ^ ] key].

<b>Before Use</b>	<b>Printer main components / Functions</b>
Setup	Vacuum table dimensions
Various Settings	Supported media
Basic Operations	Important Notes for using this product
Advanced Operations	Connecting to a computer
Maintenance	System configurations of this product
When problems occur	
Appendix	

## key

Tap to access to the Media Setting submenus; [Set Media] [Height].

- The menu [Media Setting1 Set Media] appears.
- Use  /  key to select the submenu you want to access and tap  key. The display goes to the settings of the selected menu.
- By tapping  Home key, the display will return to [Print Ready] or [Set media. then Tap [ ^ ] key].

## [Enter] key

Tap to display the time until the next ink agitation is required.

For details, see “ [Agitating ink from the direct key](#) ”P.175

You can also check the time until the next ink agitation is required on VerteLith or MSM.

VerteLith : Ver8.2.0 or later

MSM : Ver9.01 or later

Before Use

Printer main components / Functions

Setup

Vacuum table dimensions

Various Settings

Supported media

Basic Operations

Important Notes for using this product

Advanced Operations

Connecting to a computer

Maintenance

System configurations of this product

When problems occur

Appendix

## Ink level indicator on the printer control panel







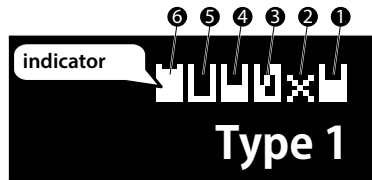

Indicators of the ink levels or presence of the ink bags appear on the display when

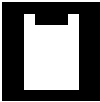
- no menu is displayed on the control panel
- ink or ink bag error occurs

Corresponding ink slot number

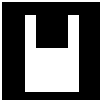

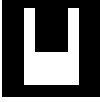
- Indicators correspond to each ink slot; slot 1 to slot 6. The right-most indicator is slot 1.
- Each indicator has the following meaning:

	Ink level 80% to 100%		Ink level 19% or less The indicator blinks when the smartchip recovery is being performed on the corresponding ink.  "Smartchip recovery" P.249
	Ink level 60% to 79%		Ink is low
	Ink level 40% to 59%		Ink is out
	Ink level 20% to 39%		No ink bag is installed

**Before Use**

**Setup**

**Various Settings**

**Basic Operations**

**Advanced Operations**

**Maintenance**

**When problems occur**

**Appendix**

**Printer main components / Functions**

Vacuum table dimensions

Supported media

Important Notes for using this product

Connecting to a computer

System configurations of this product

The following illustration shows the ink color assignment of each ink slot.

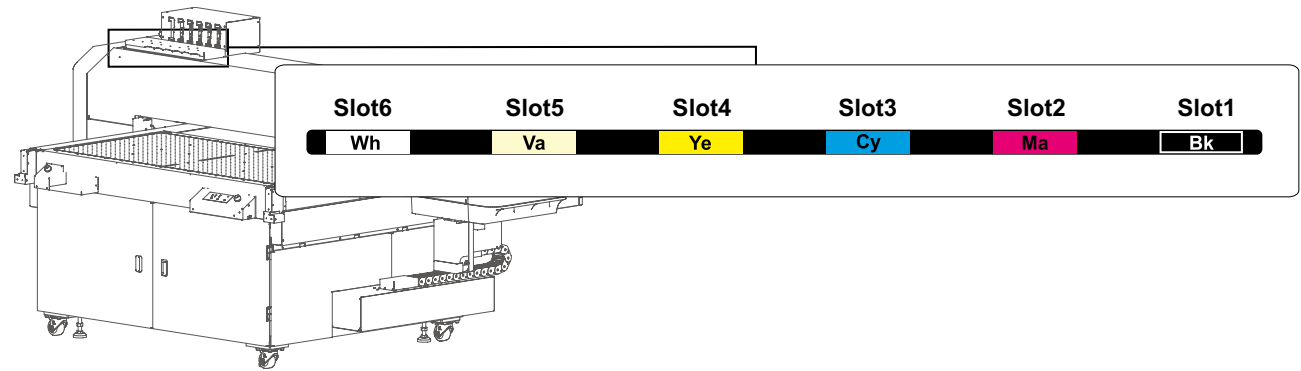

## Before Use

### Setup

### Various Settings

### Basic Operations

### Advanced Operations

### Maintenance

### When problems occur

### Appendix

## Printer main components / Functions

Vacuum table dimensions

Supported media

Important Notes for using this product

Connecting to a computer

System configurations of this product

## Vacuum control panel

Select a zone to activate suction and adjust suction volume.

☞ "How to operate vacuum control panel" P.39

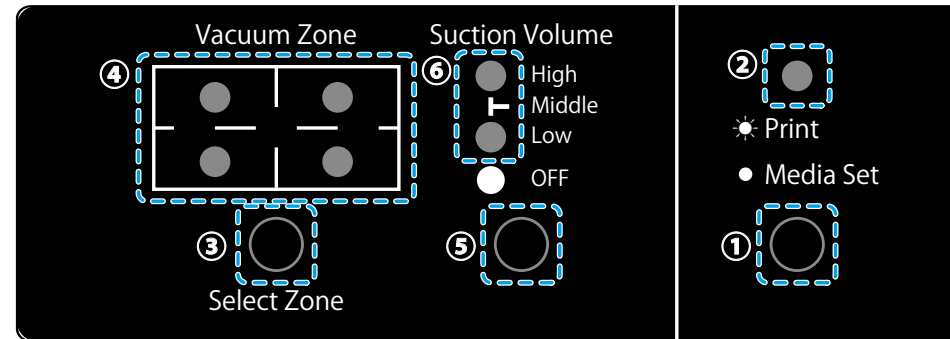

①	Print/Media Set switch	Set to [Print] when printing images. Set to [Media Set] when loading or removing media. ☞ "Select Print/Media Set" P.39
②	Print/Media Set LED	The LED indicates the status of Print/Media Set switch. Solid green : Print, Off : Media Set
③	Select Zone button	Select a zone you want to activate vacuum suction. ☞ "Select vacuum zones" P.40 For the position of each zone, see "Vacuum table dimensions" P.42 .
④	Vacuum Zone LED	The LED of the selected vacuum zone lights up.
⑤	Suction Volume button	Select the suction volume.
⑥	Suction Volume LED	The LED of the selected suction volume lights up.
Foot switch : Pause and resume of the suction by foot switch.		

Before Use

Printer main components / Functions

Setup

Vacuum table dimensions

Various Settings

Supported media

Basic Operations

Important Notes for using this product

Advanced Operations

Connecting to a computer

Maintenance

System configurations of this product

When problems occur

Appendix

## How to operate vacuum control panel

### Important !

To ensure safety operation, make sure to set this switch to [Media Set] when working on the vacuum table (e.g. loading/removing media).

### Select Print/Media Set

Print state : Printer is operable (Print/Media Set LED turns on green)

Media Set state : Printer is inoperable (Print/Media Set LED turns off)

Make sure to set this switch to [Media Set] when loading or removing media from the vacuum table.

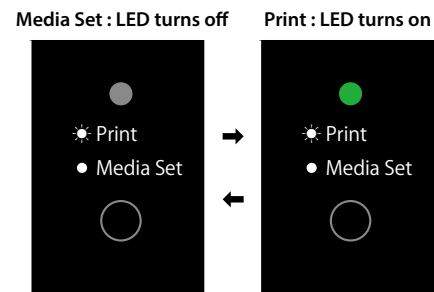

### Note

The switch cannot be set to [Media Set] while printing is in progress.

Before Use

Printer main components / Functions

Setup

Vacuum table dimensions

Various Settings

Supported media

Basic Operations

Important Notes for using this product

Advanced Operations

Connecting to a computer

Maintenance

System configurations of this product

When problems occur

Appendix

## Select vacuum zones

Select a zone where media is loaded to activate suction.

Each time the Select Zone button is pressed, the vacuum zone selection switches in the following order:

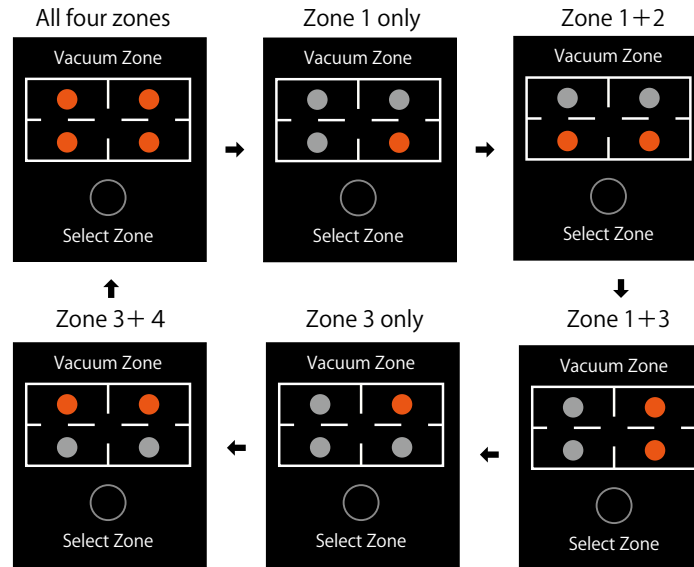

### Note

Vacuum zones cannot be changed while printing.

Before Use

Printer main components / Functions

Setup

Vacuum table dimensions

Various Settings

Supported media

Basic Operations

Important Notes for using this product

Advanced Operations

Connecting to a computer

Maintenance

System configurations of this product

When problems occur

Appendix

## Select suction volume

Select the suction volume.

Each time the Suction Volume button is pressed, the volume switches in the following order:

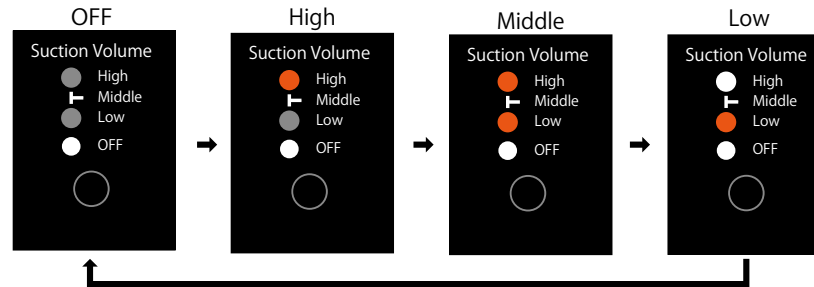

### Note

Suction volume cannot be changed while printing.

The suction volume active LED blinks when

- the suction was stopped automatically by the printer after printing
- the suction was stopped by foot switch

Before Use

Printer main components / Functions

Setup

Vacuum table dimensions

Various Settings

Supported media

Basic Operations

Important Notes for using this product

Advanced Operations

Connecting to a computer

Maintenance

System configurations of this product

When problems occur

Appendix

# Vacuum table dimensions

The following figure illustrates the dimensions of the vacuum table of this printer and each vacuum zone.

Printer rear side

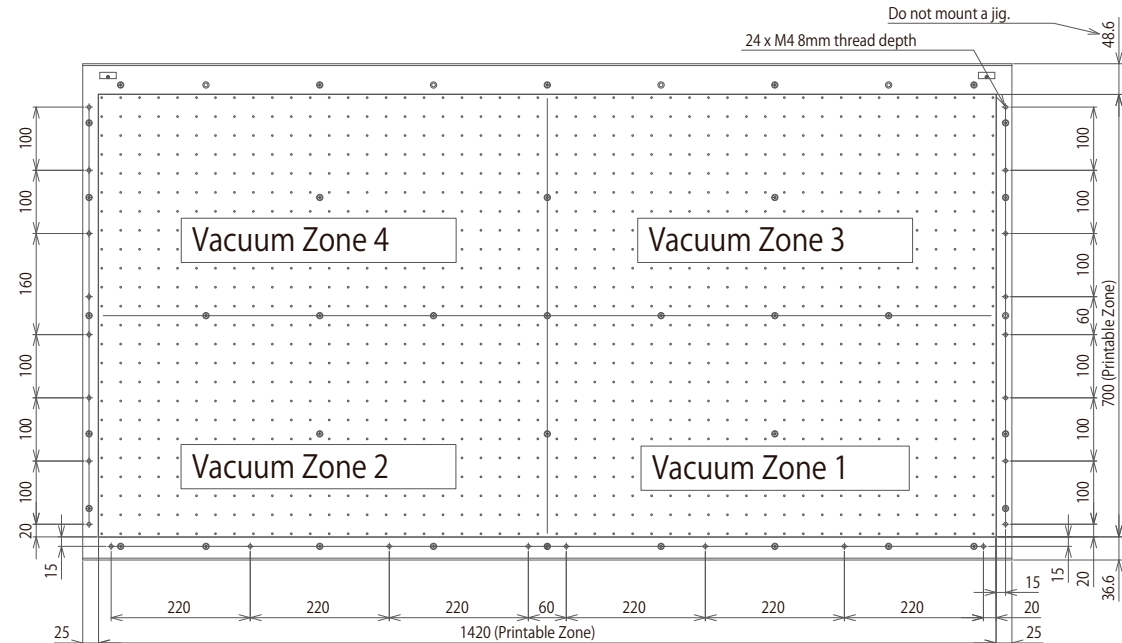

Printer front side

The table has 24 screw holes for jig installation using M4 screws.

A jig cannot be mounted on the area 48.6 mm from the rear end of the table.

Before Use

Printer main components  
/ Functions

Setup

Vacuum table dimensions

Various  
Settings

Supported media

Basic  
Operations

Important Notes for  
using this product

Advanced  
Operations

Connecting to a computer

Maintenance

System configurations of  
this product

When problems  
occur

Appendix

# Supported media

## Media size

The following media can be used on this printer.

Maximum width	1420 mm
Maximum length	700 mm
Maximum thickness	150 mm
Surface height difference	approximately up to 0.5 mm
Weight	up to 50 kg/m <sup>2</sup> (including jig)

### Note

For recommended media, please contact your local MUTOH dealer.

## Media handling cautions

Follow these instructions to achieve expected print quality.

Otherwise it could lead to printer failure.

- Use media with no wrinkle, fold or curl. If media does not sit flat on the table, use thin tape to secure it to the table to avoid warps.
- If media has a chance to be deformed while printing, use thin tape to secure it to the table to avoid striking the print head.
- Do not use heat-sensitive media. It will deform during ink curing by UV light.
- To print on an object that rolls (such as golf ball, pen), use a jig to make sure it does not roll.
- When loading a small and heavy object or jig on the table, place it as close to the center of the table as possible.
- Printing on non-flat surface media will generate ink mist, causing malfunction or damage to the printer.

<b>Before Use</b>	<b>Printer main components / Functions</b>
<b>Setup</b>	<b>Vacuum table dimensions</b>
<b>Various Settings</b>	<b>Supported media</b>
<b>Basic Operations</b>	<b>Important Notes for using this product</b>
<b>Advanced Operations</b>	<b>Connecting to a computer</b>
<b>Maintenance</b>	<b>System configurations of this product</b>
<b>When problems occur</b>	
<b>Appendix</b>	

- When printing on non-flat objects and the distance between the lowest print surface and the print head is large, the print result may not be satisfactory. If the print surface has more than 0.5 mm height difference, the Low Speed mode is recommended for printing. This can reduce the chance of printing misalignment, ink mist and bleeding.  
 [" Low Speed "P.102](#)
- Printing on a light reflective material may have a chance to cure the ink on the print head, causing malfunction or damage to the printer. To print on such materials, it is recommended to mask the non-print area on the material.

## Load media correctly

- When loading media on the vacuum table, make sure to place it on an appropriate position and enter the media information correctly. Entering wrong information will cause the printer to print beyond the media and onto the table. If the ink is sticking to the table, it will be cured by UV light and will not be removed.
- Do not place any objects on the sensing area of the media height detector while the printer is in operation. This will cause false detection and will cause the printer unable to print correctly.
- The area in front of the guide line on the front side of the table is outside the sensing area of the media height detector. Do not place any objects (including jig) which are higher than the media placed on the table here. This will cause the print head to strike it. See the following section for details.

 [" Printable area "P.134](#)

Before Use

Printer main components  
/ Functions

Setup

Vacuum table dimensions

Various  
Settings

Supported media

Basic  
Operations

Important Notes for  
using this product

Advanced  
Operations

Connecting to a computer

Maintenance

System configurations of  
this product

When problems  
occur

Appendix

# Important Notes for using this product

## Do not power off the printer

This printer must be powered on all the time. While not in use, make sure to put it into sleep mode. Do not power off or disconnect the power cord. Failure to do so will cause ink settling, leading to print defects or printer failure.

## Please use this printer regularly

Mutoh recommends to use this printer at least once a week.

If the printer is not used for a long time, the print head could get clogged, causing damage to the printer.

## Please conduct maintenance regularly

This product requires regular user maintenance.

- Run a nozzle check before printing. If the nozzles are clogged, run a head cleaning.
- Make sure to perform a daily maintenance after printing for a day. Failure to perform daily maintenance could cause print defects or printer failure.
  - ☞ ["Daily maintenance at the end of work" P.193](#)
- If you are not using the printer for an extended period\*, put it into sleep mode and perform followings:
  - \*Extended period means one week to one month.
  - Check the ink level. If the message [Ink Low] appears, replace with a new ink bag.
  - If you may not be able to perform above, follow the instruction on ["When not using the printer for a long period of time" P.236](#) to power off the printer.
  - Empty the waste ink tank when needed.
  - Clean the interior of the printer once a month.

Before Use	Printer main components / Functions
Setup	Vacuum table dimensions
Various Settings	Supported media
Basic Operations	Important Notes for using this product
Advanced Operations	Connecting to a computer
Maintenance	System configurations of this product
When problems occur	
Appendix	

## Some parts need to be replaced periodically

Following parts must be replaced after a long-term use.

- Flushing pad for flushing box, Cleaning wiper, Emitting window glass and filter of UV-LED lamp, Exhaust fan filter, Electrode needle for optional ionizer

## Use the product in a place that meets “Environmental Requirements”

- Otherwise the media height detecting accuracy may decrease, leading to inconsistency in print quality.
- Print quality may decrease due to alteration of ink or poor ink curing.

☞ “Specifications”P.261

# Connecting to a computer

You will need the following items to connect your computer to your printer.



Computer : 1

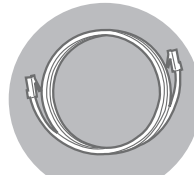

Ethernet cable : 1

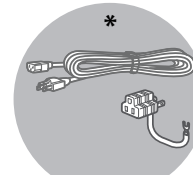

Power cord : 1



## WARNING

Make sure to use the designated power cord.  
Failure to do so could cause electric shock or fire.



## Note

Item with asterisk mark (\*) is optional accessories.

Make sure your computer meets the following requirements:

- OS : Windows 11, Windows 10
- CPU : Intel (R) Core (TM) i5 or higher
- Memory: 8GB minimum
- Use a network port that supports Gigabit Ethernet, and an Ethernet cable that supports Category 6 Gigabit Ethernet or later.



## Note

- The OS support period of software supplied from MUTOH conforms to the Microsoft support lifecycle policies.
- Please also check the system requirements of your RIP software if you are using.

**Before Use**

Printer main components / Functions

**Setup**

Vacuum table dimensions

**Various Settings**

Supported media

**Basic Operations**

Important Notes for using this product

**Advanced Operations**

**Connecting to a computer**

**Maintenance**

System configurations of this product

**When problems occur**

**Appendix**

**1** Check that the front cover is closed.

**2** Connect the power cord to the printer.

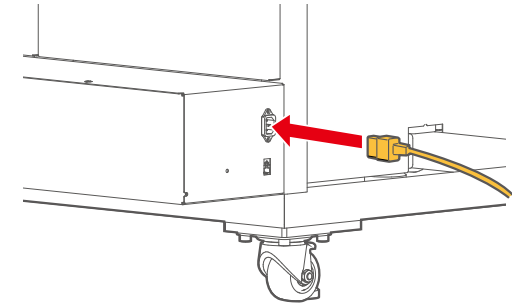

**3** Plug the power cord into a wall outlet.

3-pin plug

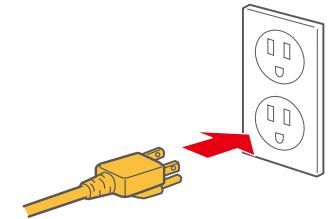

2-pin to 3-pin adapter plug

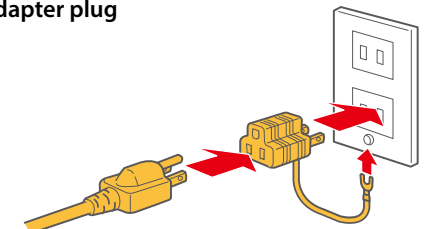

**Before Use**

Printer main components / Functions

**Setup**

Vacuum table dimensions

**Various Settings**

Supported media

**Basic Operations**

Important Notes for using this product

**Advanced Operations**

**Connecting to a computer**

**Maintenance**

System configurations of this product

**When problems occur**

**Appendix**

**4** Connect the Ethernet cable to the printer.

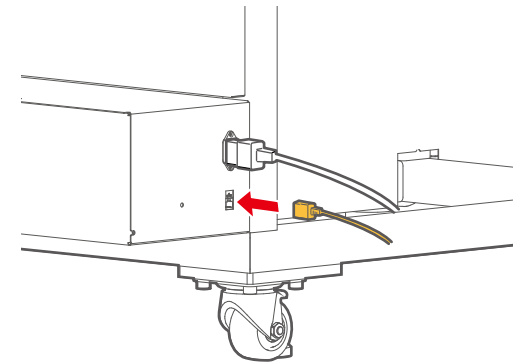

**5** Attach the cable tie to the printer and use it to secure the Ethernet cable to the printer.

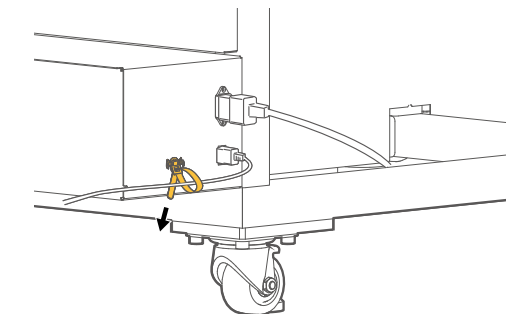
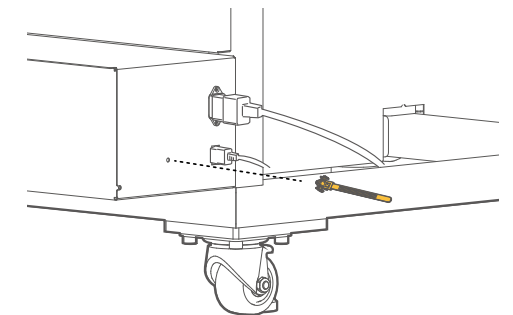

## Before Use

Printer main components / Functions

## Setup

Vacuum table dimensions

## Various Settings

Supported media

## Basic Operations

Important Notes for using this product

## Advanced Operations

**Connecting to a computer**

## Maintenance

System configurations of this product

## When problems occur

## Appendix

6

Connect the Ethernet cable to the computer.

### Note

- This illustration is an example of peer-to-peer connection between the printer and a computer. The connection method varies depending on your environment.
- If you are using the LAN connection, make sure that your printer and your computer are on the same subnet.

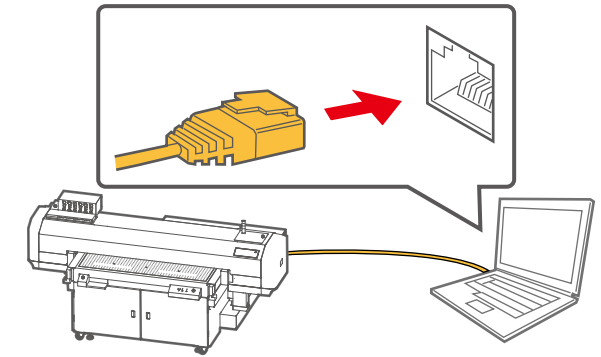

Before Use

Printer main components / Functions

Setup

Vacuum table dimensions

Various Settings

Supported media

Basic Operations

Important Notes for using this product

Advanced Operations

Connecting to a computer

Maintenance

System configurations of this product

When problems occur

Appendix

# System configurations of this product

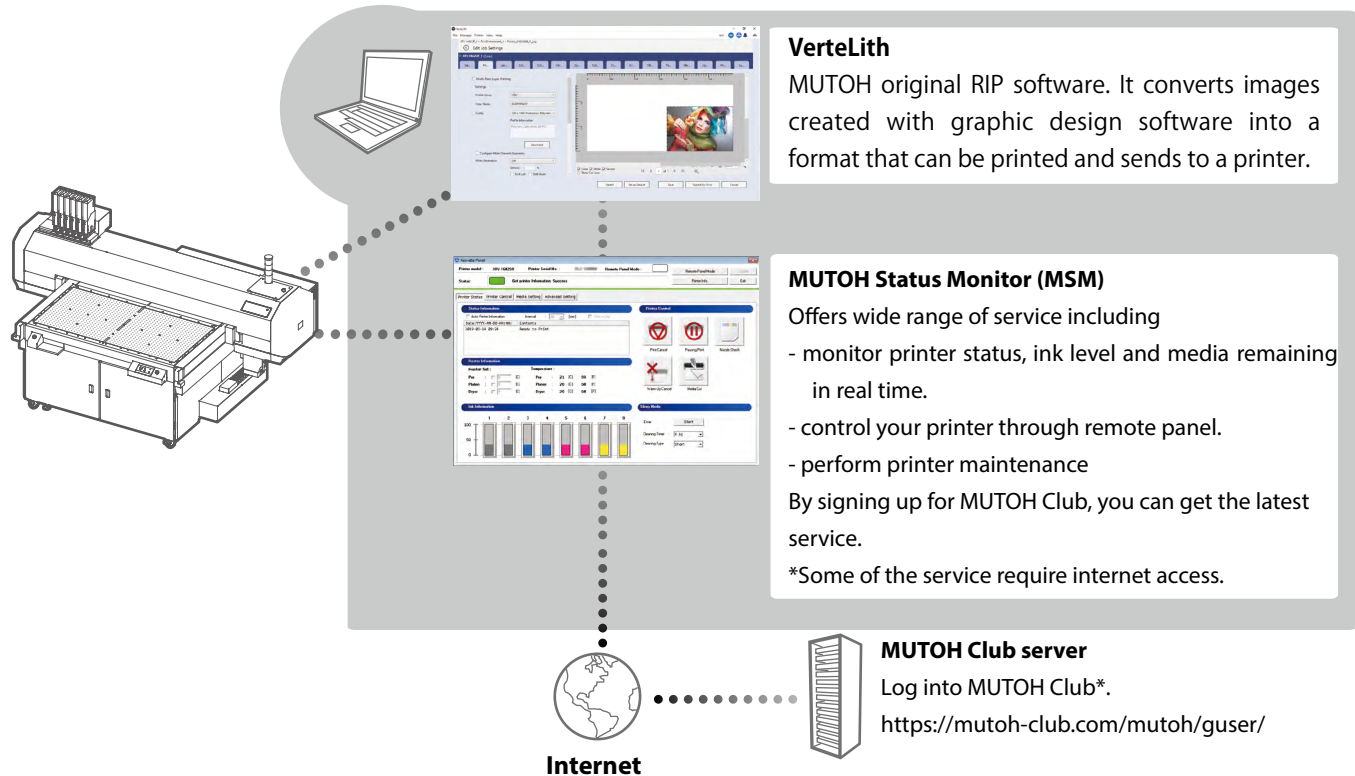

## \* MUTOH Club

- By signing up for MUTOH Club, it offers free useful contents including
- download the latest version of application, operation manual
  - download media profile
  - check printer information  
(printer information uploaded through MSM can be viewed)

# Setup

**Turning on the printer** 53

**Setting up your printer** 56

**Installing MUTOH Status Monitor** 93

**Launching/ Opening/ Exiting MSM** 94

**Installing VerteLith** 97

Before Use

Setup

Various Settings

Basic Operations

Advanced Operations

Maintenance

When problems occur

Appendix

Turning on the printer

Setting up your printer

Installing MUTOH Status Monitor

Launching/ Opening/ Exiting MSM

Installing VerteLith

# Turning on the printer

## Turn on the printer

1

Close the front cover.

2

Press and hold the Power button for more than two seconds.

- All the key light up.
- Printer initialization begins.
- When the message [Welcome] appears on the display, release the button.

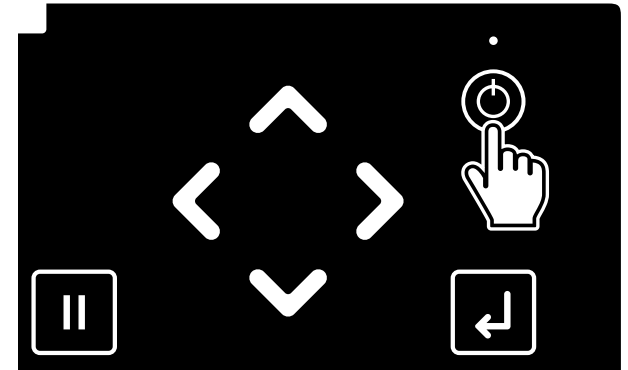

Before Use

Setup

Various Settings

Basic Operations

Advanced Operations

Maintenance

When problems occur

Appendix

Turning on the printer

Setting up your printer

Installing MUTOH Status Monitor

Launching/ Opening/ Exiting MSM

Installing VerteLith

## Turn off the printer

### Important!

This printer must be powered on all the time. While not in use, put it into sleep mode .

- Failure to do so may result in ink settling, causing print defects or printer failure.

☞ " Sleep Mode "P.145

If you are not using the printer for an extended period (maximum of one month), follow these steps to turn off the printer.

☞ " When not using the printer for a long period of time "P.236

If you temporarily turn off your printer, follow these steps.

- 1 Check that printing has finished and media and a jig have been removed from the table.
- 2 Prepare the items required for daily maintenance.  
☞ " Preparations for daily maintenance "P.195
- 3 Press and hold the Power button for more than two seconds.

- The message [Daily Maintenance Start -> Enter] appears

### Note

Tapping  Cancel key will turn off the printer without performing a daily maintenance.

☞ " 3. Skip daily maintenance and power off the printer "P.238

- Powering off without daily maintenance could cause nozzle clogging. Normally make sure to perform a daily maintenance.

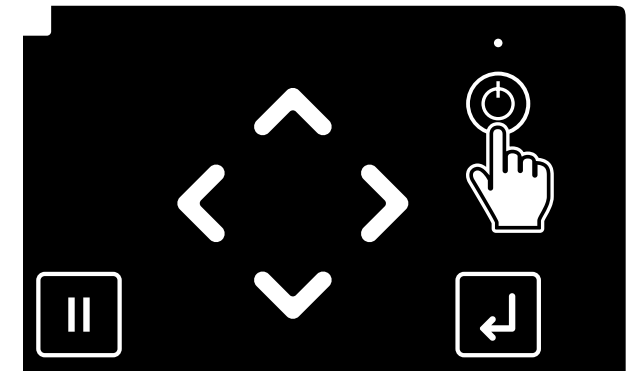



Before Use	Turning on the printer
<b>Setup</b>	Setting up your printer
Various Settings	Installing MUTOH Status Monitor
Basic Operations	Launching/ Opening/ Exiting MSM
Advanced Operations	Installing VerteLith
Maintenance	
When problems occur	
Appendix	

- 
- 4** Tap  Enter key.
- The gantry moves to the back of the printer.
  - The message [Unload Media then Tap Enter] appears on the control panel.
- 

- 5** Remove media and the jig and tap  Enter key.
- The message [Please Wait] appears.
  - The gantry and the carriage will move to the maintenance position.

 **Note**

If any obstacle is detected, the message [Unload Media then Tap Enter] will appear again. Remove media and the jig, and tap  Enter key.

- 
- 6** The message [Daily Maintenance End -> Enter] appears.
- You can start a daily maintenance.
  -  ["Preparations for daily maintenance" P.195](#)
  - Once the maintenance has finished, tap  Enter key.
  - The message [Please Wait] appears.
- 

- 7** [Cleaning \* \* % ] appears.
- The printer automatically performs "Short" cleaning.
- 

- 8** Once the cleaning has finished, the message [Power Off] appears and the printer begins powering off.
-

Before Use

Setup

Various Settings

Basic Operations

Advanced Operations

Maintenance

When problems occur

Appendix

Turning on the printer

Setting up your printer

Installing MUTOH Status Monitor

Launching/ Opening/ Exiting MSM

Installing VerteLith

# Setting up your printer

Follow this flow to complete the initial setup of your printer.

## Configure the initial settings

- Assign the IP address of your printer.

## Activate the printer

## Perform initial cleaning to initial ink charging

- Load ink bags and fill the print head with ink.

## Load media

- Place a paper for nozzle check printing on the table.

## Run a nozzle check and cleaning

- Run a nozzle check and perform cleaning if nozzle clogs.

## Perform print head and bidirectional calibrations

- Align ink dot placement between two print heads and in bidirectional printing.

## Installing MUTOH Status Monitor

- Install MUTOH Status Monitor (MSM) on your computer.

Setup is complete!

Before Use	Turning on the printer
<b>Setup</b>	<b>Setting up your printer</b>
Various Settings	Installing MUTOH Status Monitor
Basic Operations	Launching/ Opening/ Exiting MSM
Advanced Operations	Installing VerteLith
Maintenance	
When problems occur	
Appendix	

You will need the following items other than supplied accessories for this procedure.



- \* 1 The supported media size is as follows:
- Size : 1420 mm x 700 mm
  - Thickness : up to 150 mm
  - Surface height difference : approximately 0.5 mm maximum
  - Weight : up to 50kg /m<sup>2</sup>
- \* 2 Optional accessories or consumable supplies.

## Configure the initial settings

Configure the display of your printer.

- 1 Turn on the Power button.  
 "Turn on the printer" P.53

### Important!



When the printer is started for the first time, the gantry will move from the center to the back of the printer (home position).

- 2 Select the language of your printer.
  - [Language: English] appears for the first time.
  - Use / key to select the language and tap Enter key.

Before Use	Turning on the printer
<b>Setup</b>	<b>Setting up your printer</b>
Various Settings	Installing MUTOH Status Monitor
Basic Operations	Launching/ Opening/ Exiting MSM
Advanced Operations	Installing VerteLith
Maintenance	
When problems occur	
Appendix	



**3** Select the unit of length.

- [Length : mm ] appears.





Use  /  key to select the unit of length and tap  Enter key.

**4** Select whether to display the ink level indicator.

- [Remain Ink : Off] appears.





Use  /  key to select between [On] and [Off] and tap  Enter key.

**5** Assign an IP address of your printer.

- [IP Address : 192. 168. 1. 253] appears.
-  /  key : increase or decrease numbers.
-  key: move the cursor to the previous digit number.
-  key: move the cursor to the next digit number.

Once entered, tap  Enter key.

**6** Assign a subnet mask of your printer.

- [Subnet Mask : 255. 255. 255. 0] appears.
-  /  key : increase or decrease numbers.
-  key: move the cursor to the previous digit number.
-  key: move the cursor to the next digit number.





Enter all the digits.

Once entered, tap  Enter key.

Before Use	Turning on the printer
<b>Setup</b>	<b>Setting up your printer</b>
Various Settings	Installing MUTOH Status Monitor
Basic Operations	Launching/ Opening/ Exiting MSM
Advanced Operations	Installing VerteLith
Maintenance	
When problems occur	
Appendix	

**7**

**Assign a gateway of your printer.**

- [Getaway : 192.168.1.254] appears.
-  /  key : increase or decrease numbers.
-  key : move the cursor to the previous digit number.
-  key : move the cursor to the next digit number.

Enter all the digits.

Once entered, tap  Enter key.

**8**

**Select whether to enable beep sound for errors.**

- [AlertBuzzer : On] appears.
- Use  /  key to select between [On] and [Off] and tap  Enter key.

**9**

The message [Initializing] appears. Printer initialization begins.

Before Use

Turning on the printer

Setup

Setting up your printer

Various Settings

Installing MUTOH Status Monitor

Basic Operations

Launching/ Opening/ Exiting MSM

Advanced Operations

Installing VerteLith

Maintenance

When problems occur

Appendix

## Activate the printer

When the message [Activation required] appears, use one of the following methods to activate your printer.

☞ "Activation from the printer control panel" P.60





☞ "Activation through Internet" P.61

### Note

While the above message is displayed, you can redo the initial settings (e.g. IP address etc.) by tapping  Home key.

## Activation from the printer control panel

- 1 When the message [Activation required] appears, tap  Enter key.
  - [0000-0000-0000-0000] appears.

- 2 Enter the 16-digit activation code.
  -  key : increase numbers.
  -  key : decrease numbers.
  -  key: move the cursor to the previous digit number.
  -  key: move the cursor to the next digit number.

Once entered, tap  Enter key.

### Note

Please obtain the activation code from your local MUTOH dealer by email.

Before Use	Turning on the printer
<b>Setup</b>	<b>Setting up your printer</b>
Various Settings	Installing MUTOH Status Monitor
Basic Operations	Launching/ Opening/ Exiting MSM
Advanced Operations	Installing VerteLith
Maintenance	
When problems occur	
Appendix	

- 3 When the message [Activation Succeeded Reboot Printer] appears, press and hold the Power button for more than two seconds to turn off the printer.
  - When the message [Power Off] appears, release the button.
  - Wait for a few seconds and then press and hold the Power button for more than two seconds to restart the printer.

## Activation through Internet

When the message [Activation required] appears, follow the instructions on Printer Activation Guide to activate your printer.

### Note

To obtain the activation code and Printer Activation Guide, access the following URL to log in to MUTOH Club and click [Register] to complete user registration.

<https://mutoh-club.com/mutoh/guser/>

Before Use

Turning on the printer

Setup

Setting up your printer

Various Settings

Installing MUTOH Status Monitor

Basic Operations

Launching/ Opening/ Exiting MSM

Advanced Operations

Installing VerteLith

Maintenance

When problems occur

Appendix

## Perform initial cleaning to initial ink charging

What you need:

- Cleaning cartridge : 8 pieces
- Ink bag : 6 pieces (Black, Cyan, Magenta, Yellow, Varnish, White)
- High-capacity ink pack adapter : 6 pieces

### Note

For handling of high-capacity ink pack adapter, see the operation manual of high-capacity ink pack adapter.

## 1. Initial Cleaning

1

When the message [Ink Charge Start ->Enter] appears, tap  Enter key.

### Note

While the above message is displayed, you can redo the initial settings (e.g. IP address etc.) by tapping  Home key.

2

When the message [Empty Waste Ink Tank then Tap Enter] appears, check that the waste ink tank is empty and tap  Enter key.

3

[Insert Cleaning Cart.] appears.

Before Use

Turning on the printer

Setup

Setting up your printer

Various Settings

Installing MUTOH Status Monitor

Basic Operations

Launching/ Opening/ Exiting MSM

Advanced Operations

Installing VerteLith

Maintenance

When problems occur

Appendix

4

Install cleaning cartridges into all the ink slots.

- Hold the cartridge with the arrow mark facing up.
- Insert it all the way in.
- [Wash PrintHead ->Enter] appears, tap  Enter key.
- [Washing Head] appears. The printer begins filling the ink lines with cleaner.
- Once the cleaner filling has finished, the message [[56] Remove Cart.] will appear.

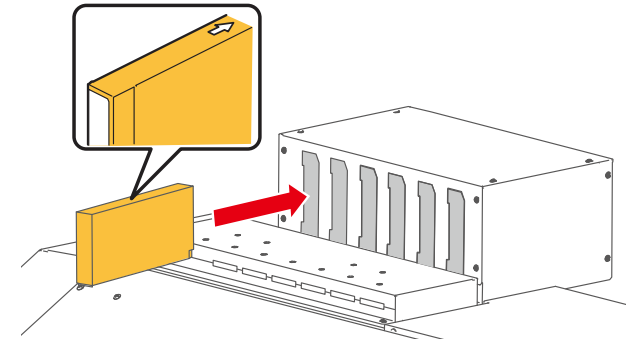

5

You will need to fill the slots 5 and 6 ink lines with cleaner again.

- Remove the cleaning cartridges from the slots 5 and 6.

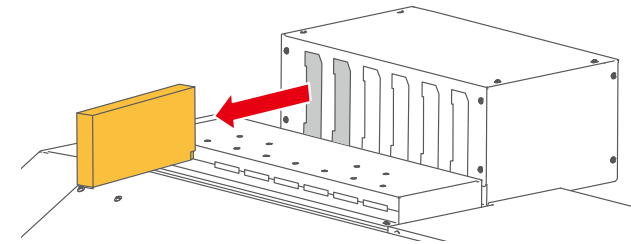

- When the message [[56] Insert Cleaning] appears, insert the new cleaning cartridges into the ink slots 5 and 6.
- [Wash PrintHead ->Enter] appears, tap  Enter key.
- [Washing Head] appears. The printer begins filling the ink lines with cleaner.

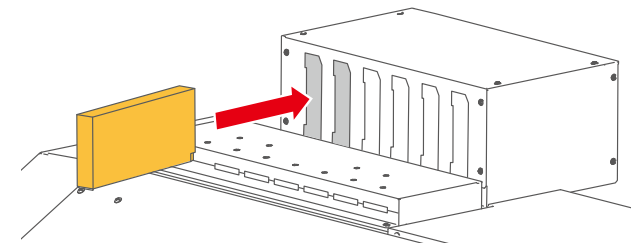

- Once the cleaner filling has finished, the message [Remove Cartridges] will appear.

Before Use

Setup

Various Settings

Basic Operations

Advanced Operations

Maintenance

When problems occur

Appendix

Turning on the printer

Setting up your printer

Installing MUTOH Status Monitor

Launching/ Opening/ Exiting MSM

Installing VerteLith

6

- Remove the cleaning cartridges from all the ink slots.
- When the message [Washing Head \* \* % ] appears, it begins flushing cleaner out of the printer.

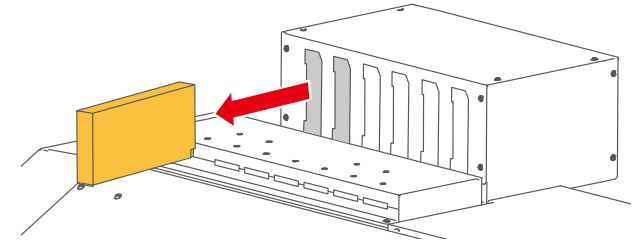

7

- Once the cleaner has flushed, the message [Empty Waste Ink Tank then Tap Enter] will appear.
- Empty the waste ink tank.
- "2. Drain waste fluid "P.64

## 2. Drain waste fluid

**Make sure to read the following section before this task.**

- "Handling "P.13
- "Ink and waste fluid "P.15

1

- Press the Print / Media Set switch on the vacuum control panel to set to [Media Set].
- The Print LED will turn off.
- "Select Print/Media Set "P.39

Before Use

Turning on the printer

Setup

Setting up your printer

Various Settings

Installing MUTOH Status Monitor

Basic Operations

Launching/ Opening/ Exiting MSM

Advanced Operations

Installing VerteLith

Maintenance

When problems occur

Appendix

2

Prepare a container to collect waste fluid.

**Important!**

The capacity of the waste ink tank is 2,000 ml. Make sure to prepare a container with at least 2,000 ml capacity.

**Note**

If the waste tank is empty or has a small amount of waste fluids, you may not be able to drain fluid from the tank, but there is no problem in use.

3

Cover the floor under the waste ink tank with waste paper or cloth.

4

Wear the rubber gloves over the polyethylene gloves.

Wear protective equipment such as goggles, protective mask, protective clothing.

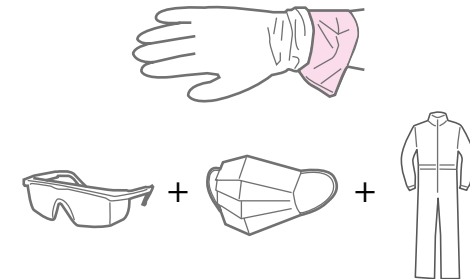

5

Open the cover of the waste ink valve case, and then take the drain tube valve out from the case.

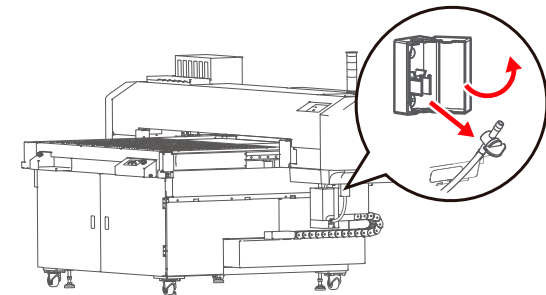

Before Use

Turning on the printer

Setup

Setting up your printer

Various Settings

Installing MUTOH Status Monitor

Basic Operations

Launching/ Opening/ Exiting MSM

Advanced Operations

Installing VerteLith

Maintenance

When problems occur

Appendix

- Put the tip of the drain tube valve in the empty container and open the valve to drain waste fluid from the waste ink tank.

**Important!**

Waste fluid may splash while draining from the waste ink tank. Make sure to put the tip of the drain tube valve in the empty container and start draining.

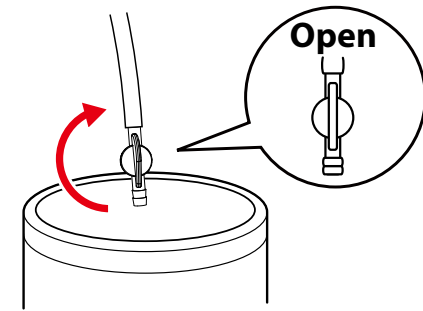

- Once you finish emptying the tank, close the drain tube valve firmly.

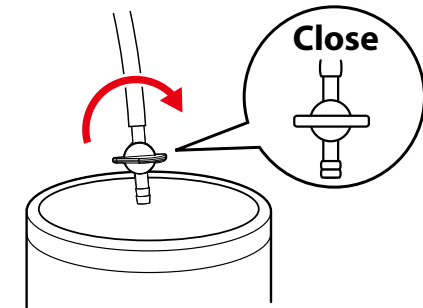

- Use a dry cloth to clean the tip of the valve.

- Hook the drain tube valve on the clamp of the waste ink valve case, then close the cover.

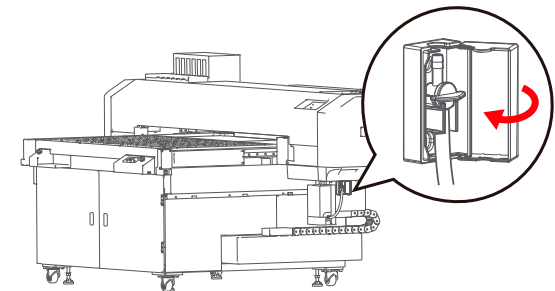

Before Use

Turning on the printer

Setup

Setting up your printer

Various Settings

Installing MUTOH Status Monitor

Basic Operations

Launching/ Opening/ Exiting MSM

Advanced Operations

Installing VerteLith

Maintenance

When problems occur

Appendix

10

Dispose of the waste fluid as industrial waste.



### WARNING

- Waste ink collected from this product is classified as industrial waste.
- You are obligated to properly dispose of waste fluid from the printer in compliance with Wastes Disposal and Public Cleansing Act and local ordinances. Delegate disposal to an industrial waste disposal contractor.
- Waste fluid from this printer is harmful to aquatic organisms. Do not allow it to reach sewage or natural water systems.

11

Press the Print / Media Set switch on the vacuum control panel to set to [ Print ].

- The Print LED will turn on.

 "Select Print/Media Set "P.39"

## 3. Initial Ink Charging

1

Check that the message [Empty Waste Ink Tank then Tap Enter] is displayed on the printer control panel.

- Tap  Enter key.

Before Use

Turning on the printer

Setup

Setting up your printer

Various Settings

Installing MUTOH Status Monitor

Basic Operations

Launching/ Opening/ Exiting MSM

Advanced Operations

Installing VerteLith

Maintenance

When problems occur

Appendix

2

Follow these steps to agitate ink in a new ink bag.

- Hold the ink bag with the ink outlet facing up and wait for three seconds.
- Invert it with the ink outlet facing down and wait for three seconds.
- Repeat this ten times (white ink : twenty times)

**Important!**

Make sure to use a new ink bag.

**Note**

There is no need to agitate varnish ink.

3 sec.



3 sec.

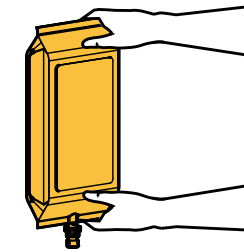

x 10

3

Insert the ink bag into the high-capacity ink pack adapter while lowering the lock lever on the adapter.

- Insert the ink bag all the way in to seat properly.

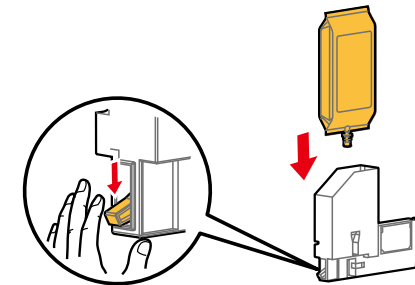

4

Ensure that the ink bag is fully seated and locked.



Before Use

Turning on the printer

Setup

Setting up your printer

Various Settings

Installing MUTOH Status Monitor

Basic Operations

Launching/ Opening/ Exiting MSM

Advanced Operations

Installing VerteLith

Maintenance

When problems occur

Appendix

5

Check that the lock lever of the high-capacity ink pack adapter is back to its original position.

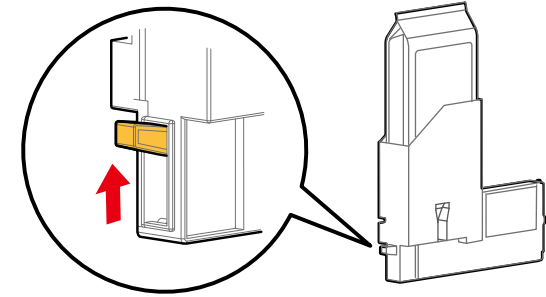

6

Cover the ink bag with the light-blocking cover.

**Note**

- Attach it so that the light-blocking cover comes inside the high-capacity ink pack adapter.
- For the details of high-capacity ink pack adapter, see the operation manual of high-capacity ink pack adapter.

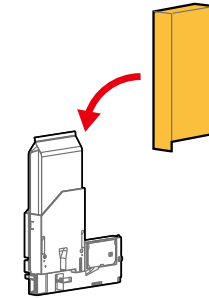

7

Insert the high-capacity ink pack adapter into the ink slot.

- Make sure to match the color of the ink bag with the color of the label attached to each ink slot.
- Insert it all the way in.
- The message [123456 No S/C Card] will appear.

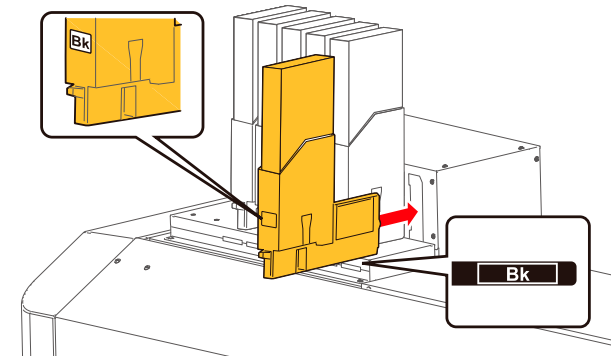

Before Use

Setup

Various Settings

Basic Operations

Advanced Operations

Maintenance

When problems occur

Appendix

Turning on the printer

Setting up your printer

Installing MUTOH Status Monitor

Launching/ Opening/ Exiting MSM

Installing VerteLith

8

Insert a smartchip card into the card slot.

[Ink Refill \*\*%] will appear.

 Note

A rubber plug on a new high-capacity ink pack adapter is strong. Even if you fully insert it into the ink slot, it may be pushed back. If the printer does not begin ink charging after you inserted a smartchip card, remove the adapter and insert it again.

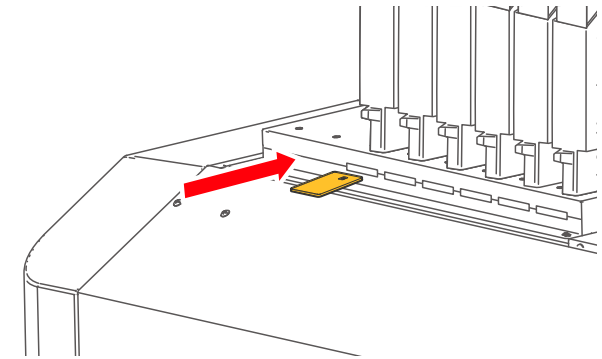

9

When [Remove Cartridges] appears, remove all the high-capacity ink pack adapters from the ink slots.

• [Ink Refill \*\*%] appears and ink is flushed out and collected in the waste ink tank.

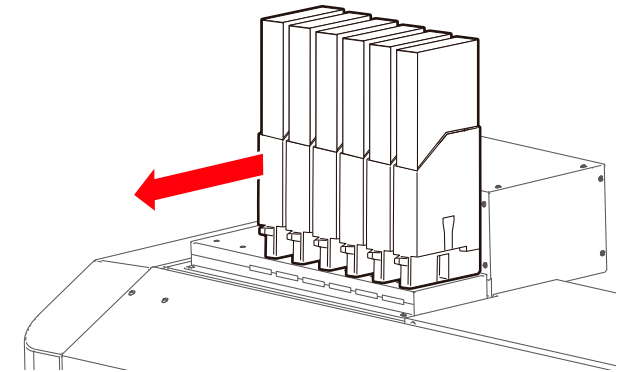

10

When the message [Empty Waste Ink Tank Then Tap Enter] appears, empty the waste ink tank.

 2. Drain waste fluid "P.64

11

Once emptied, tap  Enter key.

• [Insert InkCartridges] will appear.

Before Use

Turning on the printer

Setup

Setting up your printer

Various Settings

Installing MUTOH Status Monitor

Basic Operations

Launching/ Opening/ Exiting MSM

Advanced Operations

Installing VerteLith

Maintenance

When problems occur

Appendix

12

Insert the high-capacity ink pack adapters removed in step 9 into all the ink slots.

- Make sure to match the color of the ink bag with the color of the label attached to each ink slot.
- Insert it all the way in.
- [Ink Refill \*\*%] will appear.

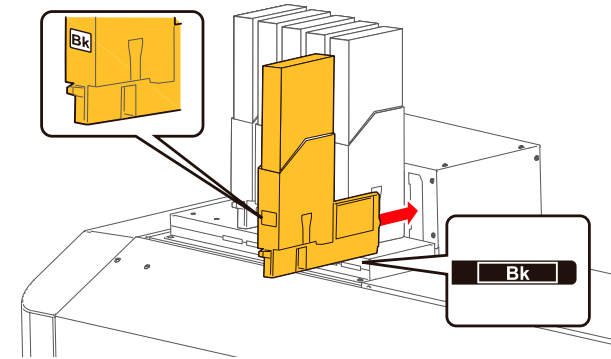

## 4. The procedure after installing ink bag

1

[Ink Refill \* \* % ] appears.

- Ink charging begins.



### CAUTION

Do not attempt the following actions during ink charging:



- Turn off the printer.
- Disconnect the power cord.
- Open the front cover or the maintenance cover.
- Move the printer.

2

When ink charging is complete, the message [Set media. Then Tap [ ^ ] key] will appear.

- The printer has been filled with ink.

Before Use

Setup

Various Settings

Basic Operations

Advanced Operations

Maintenance

When problems occur

Appendix

Turning on the printer

Setting up your printer

Installing MUTOH Status Monitor

Launching/ Opening/ Exiting MSM

Installing VerteLith

## Load media

What you need : Media (over A3 size for nozzle check print)

### 1. Place media on the table

- 1 Check that the message [Set media. Then Tap [ ^ ] key] is displayed on the control panel.
  - If it is not displayed, tap  key.

- 2 Use the Print /Media Set switch on the vacuum control panel to set to [Media Set].
  - The Print LED will turn off.

 [" Select Print/Media Set "P.39](#)

- 3 Place media on the table and select an appropriate vacuum zone and suction volume.

 [" How to operate vacuum control panel "P.39](#)

#### Note

Align the top right corner of the media with the guide line on the table.

- 4 Press the Print / Media Set switch on the vacuum control panel to set to [Print].
  - The Print LED will turn on green.

Before Use	Turning on the printer
<b>Setup</b>	<b>Setting up your printer</b>
Various Settings	Installing MUTOH Status Monitor
Basic Operations	Launching/ Opening/ Exiting MSM
Advanced Operations	Installing VerteLith
Maintenance	
When problems occur	
Appendix	

- 5** Check that the message [Set media. Then Tap [ ^ ] key] is displayed on the control panel and tap key.
- [ \*\* : Detailed-Set : On] appears.
  - Tap Enter key.

**Note**

About the "Detailed-Set" menu

- This menu is only displayed when the user type is selected for the first time.
- When set to [On], you will need to tap key and specify the settings in the menus [Media Height] [Confirm Height] [Obstacle Detect][Media Setting - Size] [Media Setting - Origin] every time a new media is loaded on the table.
- When set to [Off], by tapping key after loading media, the printer will become ready to print. In this case, the settings of [Media Height] [Obstacle Detect] [Media Setting - Size] [Media Setting - Origin] specified in the currently selected user type will be used for printing.
- Even if [Off] is selected, by tapping Cancel key while [Print Ready] or [Set media. Then Tap key] is displayed, you can specify the settings in the menus [Media Height] [Confirm Height] [Obstacle Detect] [Media Setting - Size] [Media Setting - Origin].

## 2. Specify media height and printer's behavior when obstacle is detected

- 1** Check that the menu [ \*\* : Height : Auto] is displayed. Use / key to select the method of media height setting between [Auto] and [Manual].
- [Auto] : detects media height automatically. The gantry is lifted until the media height detector does not sense any object.
  - [Manual] : manually enter the media height.
  - Tap Enter key.

**Note**

If you are using a transparent media, the printer may not be able to detect its height correctly.

" Printer cannot detect media correctly when loaded "P.254

Before Use

Turning on the printer

Setup

Setting up your printer

Various Settings

Installing MUTOH Status Monitor

Basic Operations

Launching/ Opening/ Exiting MSM

Advanced Operations

Installing VerteLith

Maintenance







When problems occur

Appendix

2

Specify the media height.

When [Auto] is selected

- [\*\* : PG Offset : (0.0-1.5) 0.0 mm ] appears.
- Use  /  key to enter the offset distance between the print head and the media and tap  Enter key.
- [\*\* : Confirm Height: Off] appears. Selecting [On] will display the message to confirm if there is a change in media height when a new media is loaded. This message will not appear when selecting [Off].  
 **Confirm Height "P.101"**
- Use  /  key to select [On] or [Off] and then tap  [Enter] key.



 **Note**

In default, the distance between the print head and media is 1.2 mm.

To widen the distance, you can specify the PG offset between 0.0 mm to 1.5 mm.

- For example) When set to [PG Offset : 0.5 mm], the distance between the print head and the media will be 1.7 mm (1.2 mm + 0.5 mm).



When [Manual] is selected

- [\*\* : Media Height : (0.0-151.5) 0.0 mm ] appears.
- Use  /  key to enter the height of the media and tap  Enter key.

 **Note**

You can enter the height of media between 0.0 mm to 151.5 mm.

Before Use	Turning on the printer
<b>Setup</b>	<b>Setting up your printer</b>
Various Settings	Installing MUTOH Status Monitor
Basic Operations	Launching/ Opening/ Exiting MSM
Advanced Operations	Installing VerteLith
Maintenance	
When problems occur	
Appendix	

**3** Specify how the printer performs when the media height detector detects obstacle during printing. Check that [ \* \* : Obstacle Detect: Auto] is displayed. Use  /  key to select from the following options:

- [Off] : Obstacle detection is disabled during printing.
- [Auto] : The printer pauses printing. After raising the height of the print head until the detector does not sense any obstacles, it will resume printing.
- [Cancel] : The printer cancels printing and displays the error message.
- [Confirm] : The printer pauses printing and displays the menu to select between resume printing or cancel printing.
- Tap  Enter key.

 **Note**

If the detector still senses obstacles even if the gantry is raised to its highest position, the printer will cancel printing and will prompt the error message.

**4** (This step is required only when [Confirm Height: On] is selected in step 2) The message [Same Media Height? H:XXX. X mm Yes] appears.

- Use  /  key to select [Yes] or [No] and then tap  key.

 **Note**

- This message appears when Height is set to [Auto] and Confirm Height is set to [On], but the following cases are excepted:
  - When you load the first media after the printer is turned on.
  - When you load the first media after changing the Height setting from [Manual] to [Auto].
- When the height of media being loaded is the same as the media loaded previously, you should select [Yes] to shorten the media height detection time.
- When the height of media being loaded is different from the media loaded previously or an error occurred after selecting [Yes], you should select [No] to detect media height again.

Before Use	Turning on the printer
<b>Setup</b>	<b>Setting up your printer</b>
Various Settings	Installing MUTOH Status Monitor
Basic Operations	Launching/ Opening/ Exiting MSM
Advanced Operations	Installing VerteLith
Maintenance	
When problems occur	
Appendix	

## 5 The message [Please Wait] appears.

- The media height detector detects media while the gantry moves from the back to the front of the printer. If no obstacle is detected, go to the next step.

☞ " 3. Enter width and length of media, print start position "P.76

If the detector senses any obstacle, an error message will be prompted on the printer control panel.

- Tap  key.



Reload the media on the table and specify the height of media again.

☞ " 1. Place media on the table "P.72

☞ " 2. Specify media height and printer's behavior when obstacle is detected "P.73

## 3. Enter width and length of media, print start position



### 1 Enter the width of media.

- Check that [ \* \* : Width : (30 - 1420) 1420 mm] is displayed.
- Use  /  key to enter the width of media and tap  Enter key.

#### Note

You can enter the width between 30 mm and 1420 mm.

### 2 Enter the length of media.





- Check that [ \* \* : Length: (30 - 700) 700 mm ] is displayed.
- Use  /  key to enter the length of media and tap  Enter key.

#### Note

You can enter the length between 30 mm and 700 mm.

Before Use	Turning on the printer
<b>Setup</b>	<b>Setting up your printer</b>
Various Settings	Installing MUTOH Status Monitor
Basic Operations	Launching/ Opening/ Exiting MSM
Advanced Operations	Installing VerteLith
Maintenance	
When problems occur	
Appendix	

### 3 Specify the print start position.







- Check that [ \* \* : Origin : PF : 0.0 CR : 0.0] is displayed.
- Use  /  key to enter the print start position for the front-back direction in "PF".
- Use  /  key to enter the print start position for the left-right direction in "CR".
- Tap  Enter key.

#### Note

You can enter the print start position in the range between 0.0 and 680 for PF, 0.0 and 1400 for CR.

- [Moving To Origin Position] appears and the gantry moves to the back of the printer.
- The carriage moves to the specified print start position with the LED pointer turned on.

### 4 Check if the LED pointer shows the correct position.

- If the position is correct, tap  Enter key.
- If the position is wrong, adjust it with the following keys:
- Use  /  key to adjust the position in the front-back direction (PF).
- Use  /  key to adjust the position in the left-right direction (CR).
- Tap  Enter key.

### 5 The message [Please Wait] appears.

- When [Print Ready] appears, you have finished loading media.

Before Use	Turning on the printer
<b>Setup</b>	<b>Setting up your printer</b>
Various Settings	Installing MUTOH Status Monitor
Basic Operations	Launching/ Opening/ Exiting MSM
Advanced Operations	Installing VerteLith
Maintenance	
When problems occur	
Appendix	

## Run a nozzle check and cleaning

Please run a nozzle check every day before printing. If nozzles are clogged, perform cleaning. This product offers the following nozzle check menus.

### Types of nozzle check patterns

- Nozzle Check F : prints a nozzle check pattern using all nozzles.  
☞ " For "Nozzle Check F" pattern "P.79
- Nozzle Check : prints a nozzle check pattern using the nozzles selected from the "Select Nozzle" menus.  
☞ " For "Nozzle Check" pattern "P.80
- Nozzle Check B : some colors of nozzle check patterns are printed with the background colors.  
☞ " For "Nozzle Check B" pattern "P.81
- Nozzle Check L : prints a nozzle check pattern by placing a paper at the left vacant space on the printer. Nozzle check pattern printing can be performed while the media for print job is being loaded on the table.  
☞ " For "Nozzle Check L" pattern "P.82

#### Important !

If you run a nozzle check print immediately after initial ink charging is complete, the following symptom may appear.

- Lines are blurred
- Image is partially not printed

In such cases, go to [Menu3: Maintenance] [Maintenance1: Cleaning] and perform [Little Charge] cleaning. Then print and check the result.

If there is no improvement, leave the printer for at least one hour and then perform cleaning or [Little Charge]. Once finished, print an image again.

If the problem still persists, please contact your local MUTOH dealer.

#### Note

When using white ink, colored media, transparent films or semi-transparent films (such as OHP film, tracing paper and more) are recommended to use for nozzle check print.

Before Use

Turning on the printer

Setup

Setting up your printer

Various Settings

Installing MUTOH Status Monitor

Basic Operations

Launching/ Opening/ Exiting MSM

Advanced Operations

Installing VerteLith



Maintenance

When problems occur

Appendix

## 1. Nozzle check procedure

For "Nozzle Check F" pattern

- 1** Load a media to print a nozzle check pattern on the vacuum table and select an appropriate vacuum zone and suction volume.
  - When loading media on the table, change the Print / Media Set switch to Media Set.
  - Place a media over A3 size in the landscape orientation.
    - ☞ "Load media" P.72
    - ☞ "How to operate vacuum control panel" P.39
- 2** Check that [ Print Ready H : XXX.Xmm Type 1 ] is displayed.
- 3** Tap  key. ☞ "Direct keys" P.34
  - [Start Printing? / Nozzle Check F] appears.
  - Tap  Enter key so that the printer begins printing a nozzle check F pattern.
- 4** Look at the nozzle check print.
  - If you see missing or thin lines on the print, go to "2. Head cleaning procedure" P.84.
  - If all lines are clearly printed, you can start printing a job.

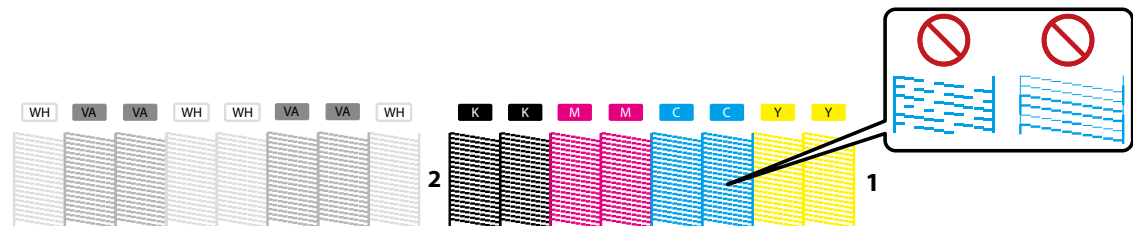

### Note

Printer information (date and time printed, serial number, firmware version) is printed next to the pattern.

Before Use

Turning on the printer

Setup

Setting up your printer

Various Settings

Installing MUTOH Status Monitor

Basic Operations

Launching/ Opening/ Exiting MSM

Advanced Operations

Installing VerteLith

Maintenance

When problems occur

Appendix

## For "Nozzle Check" pattern

- 1 Load a media to print a nozzle check pattern on the vacuum table and select an appropriate vacuum zone and suction volume.

- When loading media on the table, change the Print / Media Set switch to Media Set.
  - Place a media over A3 size in the landscape orientation
- ☞ "Load media" P.72
- ☞ "How to operate vacuum control panel" P.39 .



### Note

This "Nozzle Check" can also be run from MiniMSM.

☞ "MiniMSM" P.96

- 2 Check that [ Print Ready H : XXX.Xmm Type 1 ] is displayed.

- 3 Tap  key. ☞ "Direct keys" P.34

- When [Start Printing? / Nozzle Check F] appears, use  /  key to select [Nozzle Check].
- Tap  Enter key so that the printer begins printing a nozzle check pattern.

- 4 Look at the nozzle check print.

- If you see missing or thin lines on the print, go to "2. Head cleaning procedure" P.84 .
- If all lines are clearly printed, you can start printing a job.

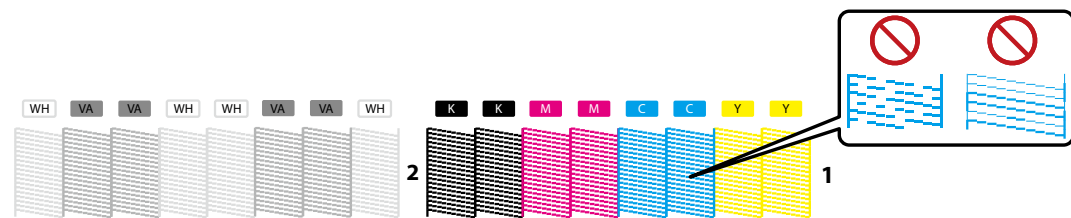

### Note

Printer information (date and time printed, serial number, firmware version, nozzle area select) is printed next to the pattern.

Before Use

Turning on the printer

Setup

Setting up your printer

Various Settings

Installing MUTOH Status Monitor

Basic Operations

Launching/ Opening/ Exiting MSM

Advanced Operations

Installing VerteLith

Maintenance

When problems occur

Appendix

## For "Nozzle Check B" pattern

**1** Load a media to print a nozzle check pattern on the vacuum table and select an appropriate vacuum zone and suction volume.

- When loading media on the table, change the Print / Media Set switch to Media Set.
  - Place a media over A3 size in the landscape orientation.
- ☞ " Load media "P.72
- ☞ " How to operate vacuum control panel "P.39



### Note

This "Nozzle Check B" can also be run from MiniMSM.

☞ " MiniMSM "P.96

**2** Check that [ Print Ready H : XXX.Xmm Type 1 ] is displayed.

**3** Tap  key. ☞ " Direct keys " P.34

- When [Start Printing? / Nozzle Check F] appears, use  /  key to select [Nozzle Check B].
- Tap  Enter key so that the printer begins printing a nozzle check B pattern.

**4** Look at the nozzle check print.

- If you see missing or thin lines on the print, go to " 2. Head cleaning procedure "P.84 .
- If all lines are clearly printed, you can start printing a job.

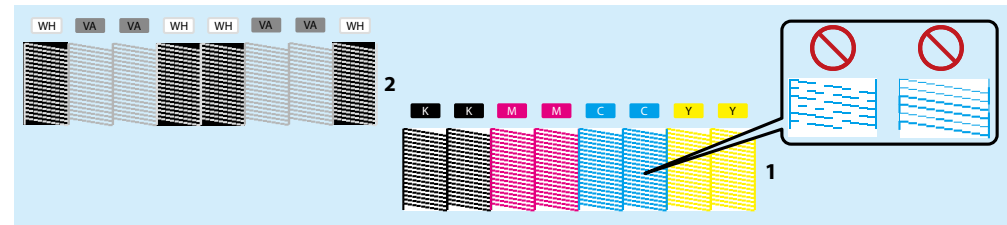

### Note

- The above illustration is an example of "Nozzle Check B" pattern. In this example, non-colored background area is shown in light blue.
- Printer information (date and time printed, serial number, firmware version, nozzle area select) is printed next to the pattern.

Before Use

Turning on the printer

Setup

Setting up your printer

Various Settings

Installing MUTOH Status Monitor

Basic Operations

Launching/ Opening/ Exiting MSM

Advanced Operations

Installing VerteLith

Maintenance

When problems occur

Appendix

## For "Nozzle Check L" pattern

- 1 Open the front cover.
  - [Cover Open] appears and the printer stops operation.

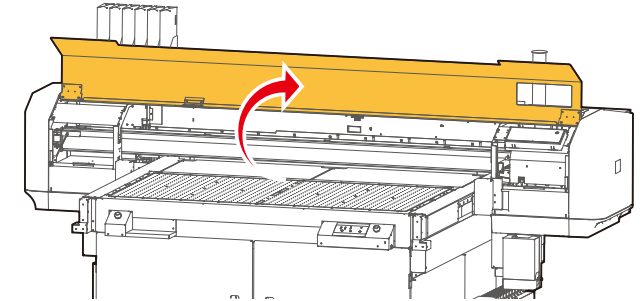

- 2 Load a media to print a nozzle check pattern at the "nozzle check L" space on the left side of the gantry.
  - Place media at least A6 size (105mm x 148mm) by aligning to the right end of the space.
  - Tape the media with masking tape or similar to avoid warps.

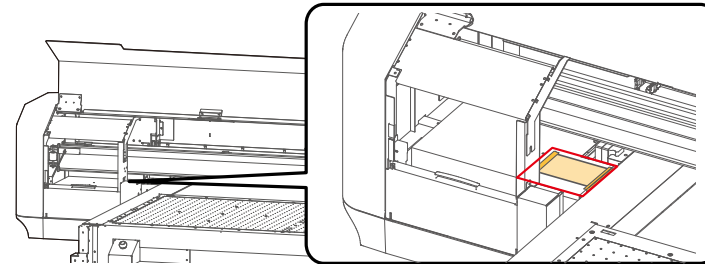

### Note

This "Nozzle Check L" can also be run from MiniMSM.

 ["MiniMSM" P.96](#)

- 3 Close the front cover.
  - [Cover Open] disappears and the printer becomes operational.

Before Use

Turning on the printer

Setup

Setting up your printer

Various Settings

Installing MUTOH Status Monitor

Basic Operations

Launching/ Opening/ Exiting MSM

Advanced Operations

Installing VerteLith





Maintenance

When problems occur

Appendix

4

Tap  key.  "Direct keys" P.34

- When [Start Printing? / Nozzle Check F] appears, use  /  key to select [Nozzle Check L].
- Tap  key so that [Nozzle check L/ Start -> Enter] will appear.
- Tap  Enter key. The printer begins printing a nozzle check L pattern.

 **Note**

If media is not loaded, [Nozzle Check L Start -> Enter] will appear.

 [Direct keys P.34](#)

5

Look at the nozzle check print.

- If you see missing or thin lines on the print, go to "2. Head cleaning procedure" P.84.
- If all lines are clearly printed, you can start printing a job.

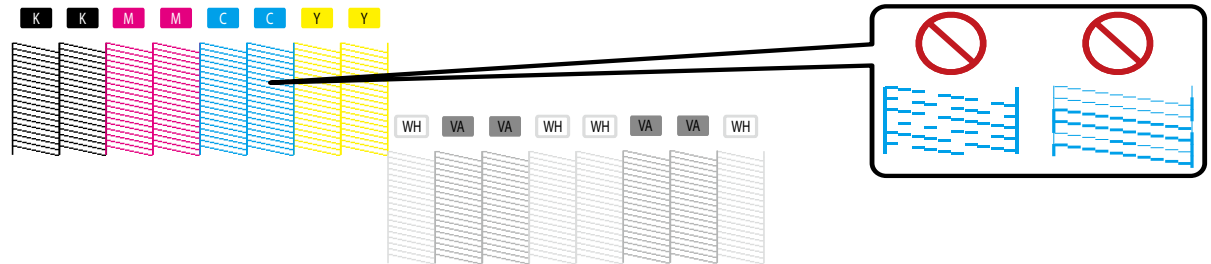

 **Note**

Printer information (date and time printed, serial number, firmware version, nozzle area select) is printed next to the pattern.

Before Use

Turning on the printer

Setup

Setting up your printer

Various Settings

Installing MUTOH Status Monitor

Basic Operations

Launching/ Opening/ Exiting MSM

Advanced Operations







Installing VerteLith

Maintenance

When problems occur





Appendix

## 2. Head cleaning procedure

- 1 Check that [Print Ready H : XXX.Xmm Type 1] or [Set media. then Tap [ ^ ] key] is displayed.
- 2 Tap  key.  
 "Direct keys "P.34
- 3 When [Clean Print Head? Short] appears, use  /  key to select the cleaning mode you want to perform.
  - Tap  Enter key.
  - The cleaning cycle begins.
- 4 Run a nozzle check pattern again.  
 "1. Nozzle check procedure "P.79
  - If the problem persists, repeat normal cleaning.

### Note

**If missing lines persists after several attempts of "Normal" cleaning, refer to the following coping strategies.**

1. Perform the "Long" cleaning. (If the problem persists, go to the next step.)
2. Perform the following cleaning. (If the problem persists, go to the next step.)
  -  "Cleaning flow" P.209
3. Go to Maintenance menu > Cleaning menu and perform "Little Charge" cleaning. (If the problem persists, go to the next step.)
  -  "Head cleaning" P.204
4. Perform the soak cleaning:
  -  "Soak Cleaning" P. 206
5. If nozzle still clogs, you can select the nozzles that do not suffer from clogging to continue printing.
  -  "Select Nozzle" P.113

Before Use

Turning on the printer

Setup

Setting up your printer

Various Settings

Installing MUTOH Status Monitor

Basic Operations

Launching/ Opening/ Exiting MSM

Advanced Operations

Installing VerteLith

Maintenance

When problems occur

Appendix

## Perform print head and bidirectional calibrations

Print head and bidirectional calibrations must be performed when you use this printer for the first time or when you change printing conditions (media height setting, PG offset setting).

This calibration has two menus: "Adjust Head" and "Adjust Print". After performing "Adjust Head" calibration, you must perform "Adjust Print" calibration as well. "Adjust Head" calibration only may cause dot placement misalignment.

 ["Adjust Print" calibration "P.88](#)



### "Adjust Head" calibration

This printer has two print heads. In this calibration, you will print an adjustment pattern to check for misalignment between two print heads (color and white) and calibrate dot placement.

This menu has two calibration methods:

- Standard : Standard menu adjusts the dot placement position for the print mode specified in the currently selected user type. When you calibrate with this menu, please select the same print mode in your RIP software.
- Custom : Custom menu adjusts the dot placement position for all the printing conditions that can be changed in the RIP software. Print quality (for color and white printing) can be optimized even if the print mode settings in the RIP software and the printer are different.

#### Note

- If the following problem appears, try "Adjust Head" calibration. The print quality may improve.  
The print quality of bidirectional printing is not good (color and white misalignment is noticeable)  
 ["Adjust Print" calibration "P.88](#)  
The print quality (of color and white printing) does not improve even if "Adjust Print" calibration is performed.
- After performing "Adjust Head" calibration, you must perform "Adjust Print" calibration as well. "Adjust Head" calibration only may cause dot placement misalignment.  
 ["Adjust Print" calibration "P.88](#)
- If you change the print mode after performing "Adjust Head" calibration from the "Standard" menu, make sure to perform "Adjust Head" calibration again.
- If you change the print mode after performing "Adjust Head" calibration from "Custom" "Fine Pattern ALL", there is no need to perform this calibration again as it calibrates dot placement position for all print modes.
- If you want to use the different print mode in your RIP software from the mode specified in the printer control panel, make sure to run the "Adjust Head" calibration from "Custom" to check alignment in all adjustment patterns (A,B,D,E) beforehand.

Before Use

Turning on the printer

Setup

Setting up your printer

Various Settings

Installing MUTOH Status Monitor

Basic Operations

Launching/ Opening/ Exiting MSM

Advanced Operations

Installing VerteLith

Maintenance





When problems occur



Appendix

## Procedure of "Adjust Head" calibration

**1** Load a media on the table.  
 "Load media "P.72

**2** Go to the "Adjust Head" menu.





- Tap  Home key → [Menu1 Setup] appears.
- Tap  key to select [Menu2: Test Print].
- Tap  key → [Test Print1 Nozzle Check] appears.
- Tap  key to select [ Test Print8 Adjust Head].
- Tap  key → [Adjust Head1 Standard] appears.

**3** Use  /  key to select the calibration method between [Standard] and [Custom].

When [Standard] is selected

- Tap  Enter key so that an adjustment pattern will be printed.

When [Custom] is selected

- Tap  key.
- [Custom1 Fine Pattern ALL] appears.
- Use  /  key to select the type of adjustment patterns and then tap  Enter key to print the pattern selected.

### Note

Tapping  Cancel key while printing an adjustment pattern will cancel printing.

**4** Follow these steps to run the calibration.

Before Use

Setup

Various Settings

Basic Operations

Advanced Operations

Maintenance

When problems occur

Appendix

Turning on the printer

Setting up your printer

Installing MUTOH Status Monitor

Launching/ Opening/ Exiting MSM

Installing VerteLith

## Calibration procedure

**1** Look at the print and find the pattern that looks the most aligned. The “Adjust Head” patterns are printed in the center and both ends of the media.

- Select the number written under the most aligned pattern.

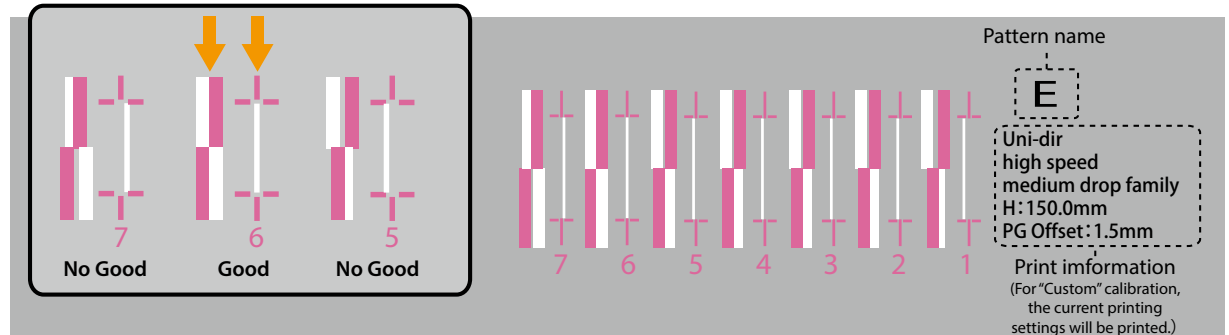

**2** Enter the number you selected.

- The display shows [PatternE : 3]. Use / key to enter the number and tap Enter key.
- In the above example, you will enter [Pattern E : 6].
- If you have selected [Adjust Head2: Custom] [Fine Pattern ALL], you will need to select and enter the number from each pattern A,B,D and E.

Before Use	Turning on the printer
<b>Setup</b>	<b>Setting up your printer</b>
Various Settings	Installing MUTOH Status Monitor
Basic Operations	Launching/ Opening/ Exiting MSM
Advanced Operations	Installing VerteLith
Maintenance	
When problems occur	
Appendix	

## "Adjust Print" calibration

In this calibration, you will print an adjustment pattern to check for misalignment in bidirectional printing and calibrate dot placement. This menu has two calibration methods:

- **Standard** : Standard menu adjusts the dot placement position for the print mode specified in the currently selected user type. When you calibrate with this menu, please select the same print mode in your RIP software.
- **Custom** : Custom menu adjusts the dot placement position for all the printing conditions that can be changed in the RIP software. Print quality can be optimized even if the print mode settings in the RIP software and the printer are different.

### Adjustment pattern for each print mode

※ The following pattern will be printed depending on the print mode and type of ink being used.

Print mode	Adjustment pattern
Build Up	Pattern E
Quality	
Production	
High Speed	Pattern D
Draft	

#### Note

- Perform "Adjust Print" calibration if you feel the print quality has changed after you changed installation site or replaced with a new media.
- If you change the print mode after performing "Adjust Print" calibration from the "Standard" menu, make sure to perform "Adjust Print" calibration again.
- If you change the print mode after performing "Adjust Print" calibration from "Custom", there is no need to perform this calibration again as it calibrates dot placement position for all print modes.
- If you want to use the different print mode in your RIP software from the mode specified in the printer control panel, make sure to run the "Adjust Print" calibration from "Custom" to check alignment in the adjustment patterns A, B, D and E beforehand.

Before Use	Turning on the printer
<b>Setup</b>	<b>Setting up your printer</b>
Various Settings	Installing MUTOH Status Monitor
Basic Operations	Launching/ Opening/ Exiting MSM
Advanced Operations	Installing VerteLith
Maintenance	
When problems occur	
Appendix	







## "Adjust Print" calibration procedure

- 1** Load a media on the table.



 "Load media "P.72"

---



  - 2** Go to the "Adjust Print" menu.

    - Tap  Home key → [Menu1 Setup] appears.
    - Tap  key twice → [User Type Type1] appears.
    - Use  /  key to select a user type you want to use and tap  Enter key.
    - [Type\*\* : 1 Print Mode] appears.
    - Tap  key to select [Type\*\* : 2 : Adjust Print].
    - Tap  key → [\*\*Adjust Print 1 Standard] appears.



---

  - 3** Use  /  key to select the calibration method between [Standard] and [Custom].

**When [Standard] is selected**

    - Tap  key → [Standard1: Confirm Pattern] appears.
    - Tap  Enter key so that a confirmation pattern will be printed.

**When [Custom] is selected**

    - Tap  key → [Custom1: Confirm Pattern] appears.
    - Tap  Enter key so that a confirmation pattern will be printed.
-  **Note**

Tapping  Cancel key while printing a confirmation pattern will cancel printing.
- 
- 4** Follow these steps to run the calibration.

Before Use

Turning on the printer

Setup

Setting up your printer

Various Settings

Installing MUTOH Status Monitor

Basic Operations

Launching/ Opening/ Exiting MSM

Advanced Operations

Installing VerteLith

Maintenance

When problems occur

Appendix

## Calibration procedure

- 1 Look at the print and check if there is any misalignment.
  - In the example below, there is misalignment of dot placement.

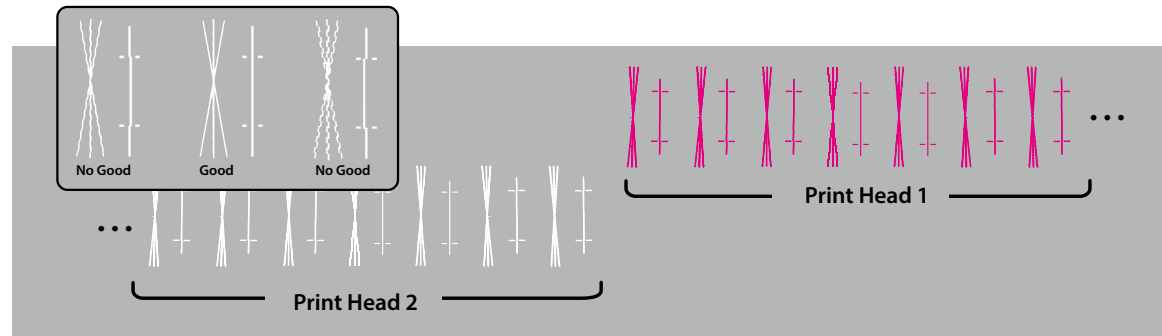

- If the amount of misalignment is large, move to step 2.
- If the amount of misalignment is small, move to step 5.

- 2 Print a rough adjustment pattern.
  - For "Custom" calibration: Select [Rough Pattern ALL] or any pattern from [Rough Pattern A], [Rough Pattern B], [Rough Pattern D] and [Rough Pattern E] and tap Enter key to print an adjustment pattern.
  - Look at the print for Print Head 1 and select the number written under the pattern that is the most aligned.

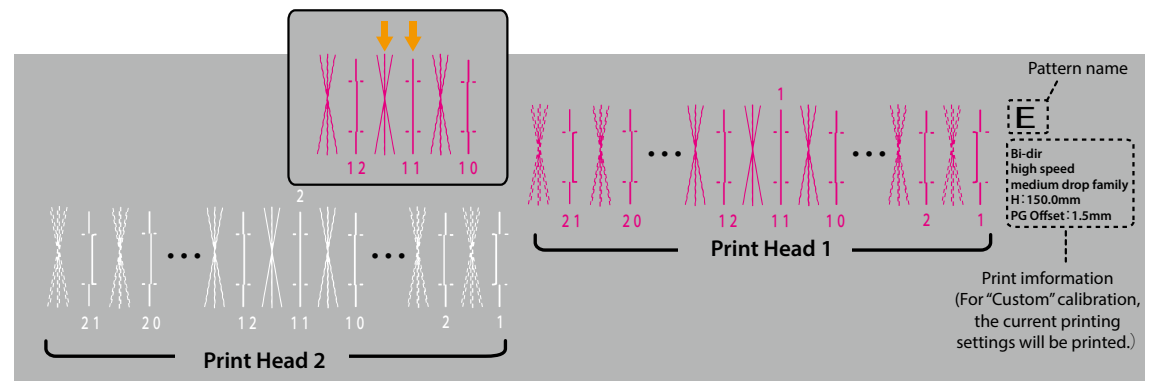

Before Use

Turning on the printer

Setup

Setting up your printer

Various Settings

Installing MUTOH Status Monitor

Basic Operations

Launching/ Opening/ Exiting MSM

Advanced Operations

Installing VerteLith



Maintenance

When problems occur

Appendix

3

Enter the number you selected.

- The display shows [PatternE1 : 11]. Use  /  key to enter the number and tap  Enter key.
- In the example shown in step 2, you should choose [Pattern E1: 11] and tap  Enter key.

4

Follow the steps 2 & 3 to do calibration for Print Head 2.

5

Print a fine adjustment pattern.



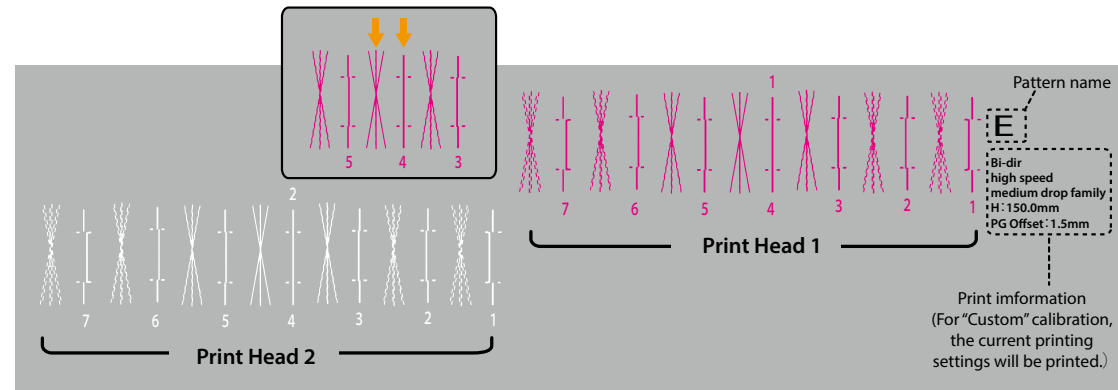

- For "Custom" calibration: Select [Fine Pattern ALL] or any pattern from [Fine Pattern A], [Fine Pattern B], [Fine Pattern D] and [Fine Pattern E] and tap Enter key to print an adjustment pattern.
- Look at the print for Print Head 1 and select the number written under the pattern that is the most aligned.



Before Use	Turning on the printer
<b>Setup</b>	<b>Setting up your printer</b>
Various Settings	Installing MUTOH Status Monitor
Basic Operations	Launching/ Opening/ Exiting MSM
Advanced Operations	Installing VerteLith
Maintenance	
When problems occur	
Appendix	

6

Enter the number you selected.

- The display shows [PatternE1: 4]. Use  /  key to enter the number and tap  Enter key.
- In the example shown in step 5, you should choose [Pattern E1: 4] and tap  Enter key.

7

Follow the steps 5 & 6 to do calibration for Print Head 2.

Before Use

Turning on the printer

Setup

Setting up your printer

Various Settings

Installing MUTOH Status Monitor

Basic Operations

Launching/ Opening/ Exiting MSM

Advanced Operations

Installing VerteLith

Maintenance

When problems occur

Appendix

# Installing MUTOH Status Monitor

Before printing, MUTOH Status Monitor (MSM) must be installed on your computer.

Once installed, follow the instructions on the MSM operation manual to complete initial set up and printer registration.

- The following software and operation manuals are available for download from MUTOH Club.

MUTOH Status Monitor (MSM)	Allows you to view printer status, change printer's settings and run a test printing.
VerteLith	MUTOH genuine RIP software that gets optimal performance from MUTOH printer and improves the work efficiency of users (a license must be purchased).
Operation Manual (for printer and software)	The following operation manuals are available in PDF format. <ul style="list-style-type: none"> <li>• XPJ-1462UF Operation Manual [Operation and Maintenance](this document)</li> <li>• MUTOH Status Monitor Operation Manual</li> <li>• VerteLith User Manual</li> </ul>

## Important!

Make sure to install MSM downloaded from MUTOH Club.

## Installing procedure

**1** Follow the instructions on the "Request for User Registration & Download" sheet supplied with this product to complete user registration and download.

**2** Unzip the file downloaded and double click on setup.exe.

Before Use

Turning on the printer

Setup

Setting up your printer

Various Settings

Installing MUTOH Status Monitor

Basic Operations

Launching/ Opening/ Exiting MSM

Advanced Operations

Installing VerteLith

Maintenance

When problems occur

Appendix

# Launching/ Opening/ Exiting MSM

## Launch MSM

Windows 11 / Windows 10

Double click the MSM icon on your desktop.

### Note

Launching from the Start menu of Windows

• Windows 11 / Windows 10

From the [Start] menu, click [All Programs] (or [All Apps]) > [MUTOH] > [MUTOH Status Monitor].



## Open MSM

Double click the MSM icon in the task tray.

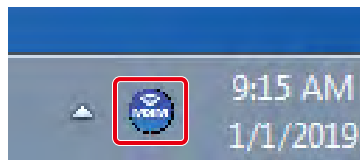

Before Use

Turning on the printer

Setup

Setting up your printer

Various Settings

Installing MUTOH Status Monitor

Basic Operations

Launching/ Opening/ Exiting MSM

Advanced Operations

Installing VerteLith

Maintenance

When problems occur

Appendix

## Open remote panel

The remote panel allows you to view the printer status or remotely operate your printer.

Click [Remote Panel].

- The remote panel opens.

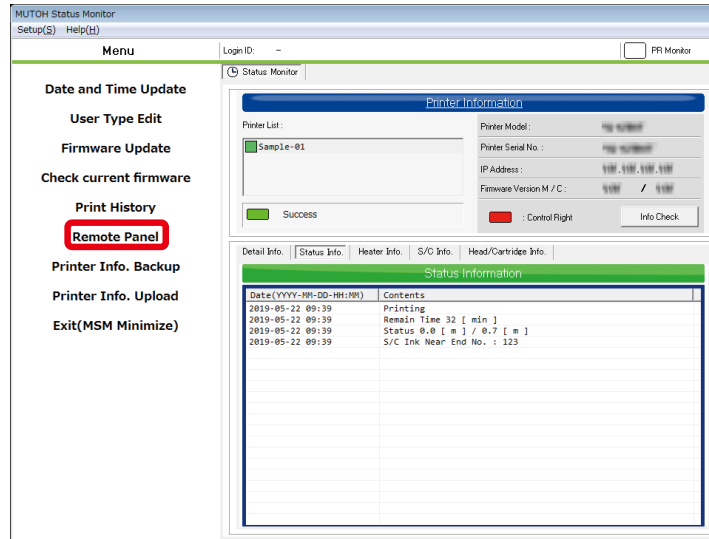

## Exit MSM

Right click the MSM icon in the task tray and click [Exit].

### Note

While you are using your printer, do not exit MSM. To close the MSM window, click [Settings] > [Close].

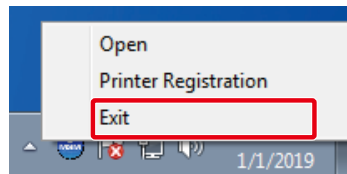

Before Use

Setup

Various Settings

Basic Operations

Advanced Operations

Maintenance

When problems occur

Appendix

Turning on the printer

Setting up your printer

Installing MUTOH Status Monitor

Launching/ Opening/  
Exiting MSM

Installing VerteLith

## MiniMSM

MSM can be downsized by enabling MiniMSM. The following operations are available from MiniMSM.

### How to open MiniMSM

Click [Settings] > [MiniMSM].

- MiniMSM appears.



#### Functions of each icon

- ▼ **Printer Select:** Select a printer registered in VerteLith.
- 📄 **Media Set:** Click this icon so that the gantry moves to the back of the printer to be able to load media. The settings specified in the currently selected user type will be used for printing.
- 🛑 **Print Cancel:** Cancel printing. You cannot resume printing.
- 🧼 **Cleaning:** Click to open the cleaning dialog. You can select the cleaning mode and perform cleaning cycle.
- 🖨️ **Nozzle check:** Click to open the nozzle check dialog. You can select the type of nozzle check menu and print a nozzle check pattern.
- ⚙️ **Setting:** Displays the Setting window.
- 🏠 **Exit:** Exit MiniMSM and open MSM.

#### Note

How to open MiniMSM from VerteLith:

- Click on the [MSM] icon on the top right so that MSM opens.
- On MSM, click [Settings] > [MiniMSM].
- MiniMSM appears.

Before Use	Turning on the printer
<b>Setup</b>	Setting up your printer
Various Settings	Installing MUTOH Status Monitor
Basic Operations	Launching/ Opening/ Exiting MSM
Advanced Operations	<b>Installing VerteLith</b>
Maintenance	
When problems occur	
Appendix	

# Installing VerteLith

After purchasing the license of VerteLith, follow the instructions on Install Guide supplied with the VerteLith package to complete user registration and installation.

Once installed, follow the VerteLith user manual to complete initial setup and printer registration.

# Various Settings

<b>Key operation</b>	<b>99</b>
<b>Print settings menu</b>	<b>100</b>
<b>Test Print menu</b>	<b>118</b>
<b>Maintenance menu</b>	<b>126</b>
<b>Printer Status menu</b>	<b>129</b>
<b>System Information menu</b>	<b>130</b>
<b>Ink Agitation menu</b>	<b>131</b>
<b>Sleep Mode menu</b>	<b>132</b>

Before Use	
Setup	Key operation
<b>Various Settings</b>	Print settings menu
	Test Print menu
Basic Operations	Maintenance menu
Advanced Operations	Printer Status menu
Maintenance	System Information menu
When problems occur	Ink Agitation menu
Appendix	Sleep Mode menu

# Key operation







You will configure the printer settings in the printer control panel.

- 1 To access the setup menu, tap  Home key.

## Note

Setup menu is not accessible while status light is blinking (printing, data converting, data receiving).

- 2 Use the following keys to select and run / confirm the menu:

- Tap  /  key to scroll through the menu.
- Tap  key to go to the menu.
- Use  /  key to select from the sub menu or enter a value.
- Tap  Enter key to confirm the setting / run the menu.
- Tap  key to return to the previous menu.

Before Use	
Setup	Key operation
<b>Various Settings</b>	<b>Print settings menu</b>
Basic Operations	Test Print menu
Advanced Operations	Maintenance menu
Maintenance	Printer Status menu
When problems occur	System Information menu
Appendix	Ink Agitation menu
	Sleep Mode menu

# Print settings menu



\*Setting range : Underline indicates the default setting.

Settings menu	Setting range	Functions
User Type	<u>Type1</u> to Type15	Create your own media preset for each media type (we call it "User Type") and save it with appropriate printer settings as "Type xx". You can define up to 15 user types.  "User Type" P.107
Print Mode	Build Up, <u>Quality</u> , Production, High Speed, Draft	Select the print mode from the options.
Effect	None, <u>i-Weave UVEx</u>	An appropriate effect option is selected automatically depending on the print mode selected.
Adjust Print "Adjust Print" calibration P.88		Perform bidirectional printing calibration to align dot placement.
Standard	Confirm Pattern, Rough Pattern, Fine Pattern	Calibrate dot placement in bidirectional printing for the print mode selected.
Custom	Confirm Pattern, Rough Pattern ALL, Rough Pattern A,B,D,E, Fine Pattern ALL, Fine Pattern A,B,D,E	Calibrate dot placement in bidirectional printing for all the printing conditions that can be changed in the RIP software.
Adjust Layer Print "Adjust Layer Print" P.108		Use this menu to adjust layer shifting in layer printing. It has the following two adjustment menus:
Head Fine Adjust	Confirm Pattern, Fine Pattern ALL, Fine Pattern A, B, D, E	Align ink dot placement between two print heads in single-pass layer printing or multi-pass layer printing.
Adjust Layer	Confirm Pattern, Rough Pattern ALL, Rough Pattern B,D,E, Fine Pattern ALL, Fine Pattern B,D,E	Adjust layer shifting in multi-pass layer printing when each layer has different drop family setting.

Before Use	
Setup	Key operation
<b>Various Settings</b>	<b>Print settings menu</b>
Basic Operations	Test Print menu
Advanced Operations	Maintenance menu
Maintenance	Printer Status menu
When problems occur	System Information menu
Appendix	Ink Agitation menu
	Sleep Mode menu

Settings menu	Setting range	Functions
Media Setting		
Set Media	Height, PG Offset, Media Height, Obstacle Detect, Width, Length, Origin	Specify the following media settings in a sequence. [Height] - [Confirm Height] - [Obstacle Detect] - [Width] - [Length] - [Origin] " Load media" P.72
Size		Use this menu if you do not use the [Set Media] menu to configure the media settings.
Width	30mm to <u>1420mm</u>	Enter the width of the media.
Length	30mm to <u>700mm</u>	Enter the length of the media.
Height		Use this menu if you do not use the [Set Media] menu. <ul style="list-style-type: none"> <li>• Auto : The printer detects the thickness of the media being loaded and automatically adjusts the height of the print head.</li> <li>• Manual : Enter the thickness of the media.</li> </ul>
PG Offset	<u>0.0 mm</u> to 1.5 mm	This option is available when Height is set to [Auto]. Specify the PG offset value so that the print head is raised for the value from the automatically adjusted height. Use this option if you want to have more margin for the distance between media and the print head.
Confirm Height	On, <u>Off</u>	This option is available when Height is set to [Auto]. <ul style="list-style-type: none"> <li>• On : The confirmation message [Same Media Height?] appears when a new media is loaded. If you repeatedly print on media with the same thickness, the [On] setting will help you shorten the time for media height detection.</li> <li>• Off : The confirmation message is not displayed when a new media is loaded.</li> </ul> Refer to step 2 and 4 in " 2. Specify media height and printer's behavior when obstacle is detected" P.73
Media Height	<u>0.0 mm</u> to 151.5mm	This option is available when Height is set to Manual. Enter the thickness of the media.

Before Use	
Setup	Key operation
<b>Various Settings</b>	<b>Print settings menu</b>
Basic Operations	Test Print menu
Advanced Operations	Maintenance menu
Maintenance	Printer Status menu
When problems occur	System Information menu
	Ink Agitation menu
Appendix	Sleep Mode menu

Settings menu	Setting range	Functions
Origin	PF: <b>0.0 mm to 680.0 mm</b> CR: <b>0.0 mm to 1400.0mm</b>	Use this menu if you do not use the [Set Media] menu. Specify the coordinate of the print start position (x position, y position) with the guide line on the vacuum table as the coordinate origin (0,0). <ul style="list-style-type: none"> <li>PF : Enter the print start position in the front-back direction (X axis) from the coordinate origin.</li> <li>CR : Enter the print start position in the left-right direction (Y axis) from the coordinate origin.</li> </ul>
Detailed-Set	<b>Off, On</b>	Select whether or not to display the [Set media] menu when loading media.  <b>" Load media" P.72</b>
Low Speed	<b>Off, 50%</b>	Select this when you want to reduce printing speed. When set to other than [Off], the print mode will switch to unidirectional printing. <ul style="list-style-type: none"> <li>This mode is effective for printing on non-flat objects (e.g. golf ball, ballpoint pen, smartphone case, etc.) to improve print quality.</li> </ul>
Obst. Check Mode	<b>Off, Auto, Cancel, Confirm</b>	You can specify how the printer performs when the media height detector detects obstacle during printing. <ul style="list-style-type: none"> <li>Off: Obstacle detection is disabled during printing.</li> <li>Auto: The printer pauses printing. After raising the height of the print head until the detector does not sense any obstacles, it will resume printing.</li> <li>Cancel: The printer cancels printing and prompts an error message.</li> <li>Confirm: The printer pauses printing and confirms you whether you want to resume or cancel printing.</li> </ul>  <b>" 2. Specify media height and printer's behavior when obstacle is detected" P.73</b>
Copy User Type	<b>Type 1 to Type 15, ALL</b>	The following settings of the selected user type can be copied to another user type: Print Mode/ Effect/ Adjustment value of Adjust Print/ Media Setting/ Adjustment value of Adjust Layer Print/ Low Speed/Obstacle Detect. When [ALL] is selected, these settings will be copied to all user types.
Initialization	<b>No, Yes</b>	Reset the settings of the selected user type.

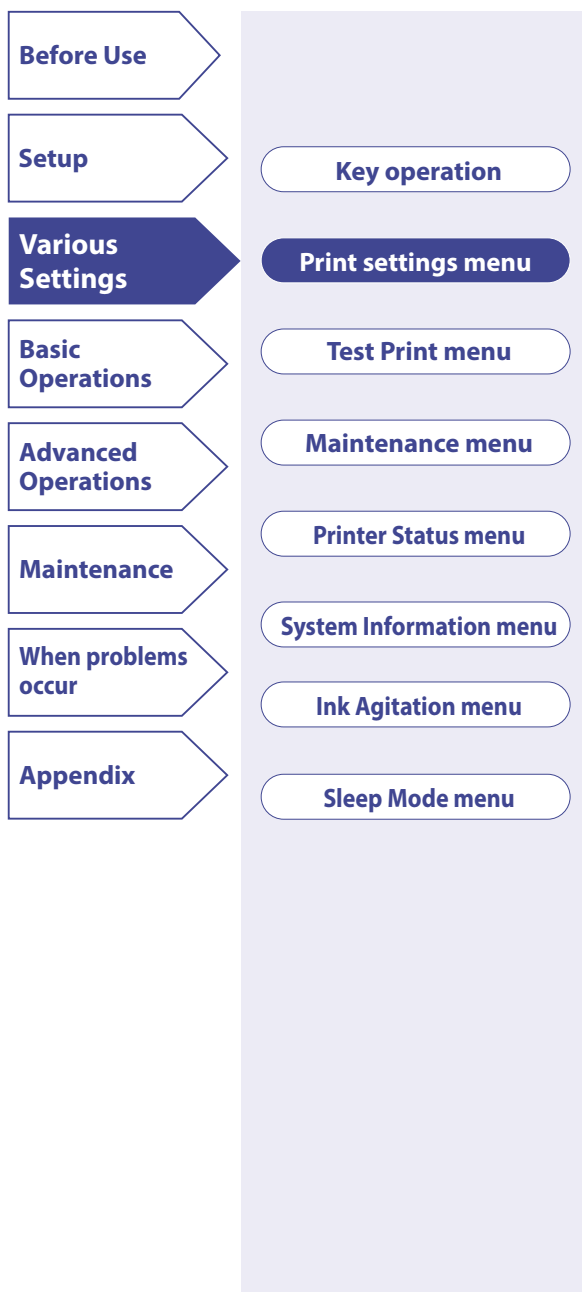





Settings menu	Setting range	Functions
<b>Advanced Settings</b>		
<b>Multi Strike</b>	<b>1 to 9(count)</b>	Specify the number of times the printer prints the same line. Increase the number of times if you want to perform high density printing on transparent media.
Layer Multi Strike (Color Layer)	1 to 9(count)	Specify this if you want to increase the number of times the printer prints the color (CMYK) layer.
Layer Multi Strike (White Layer)	1 to 9(count)	Specify this if you want to increase the number of times the printer prints the white layer.
Layer Multi Strike (Varnish Layer)	1 to 9(count)	Specify this if you want to increase the number of times the printer prints the varnish layer.
<b>Pass Wait</b>	<b>0.0 to 5.0(sec)</b>	Specify the waiting time between passes. The next pass will be printed after the specified time given.
<b>Head Travel</b>	<b>Data, Machine, Media</b>	Select the width that the print head travels for printing from the following options: <ul style="list-style-type: none"> <li>• Data: travels the data width.</li> <li>• Machine: travels the full printer width.</li> <li>• Media: travels the media width.</li> </ul>
<b>Header Dump</b>	<b>Off, On, Dump, Print</b>	Select whether to print the following dump information for the print data; data header/ the number of ink drops jetted for print data (data dot number)/ printer serial number/ firmware version. <ul style="list-style-type: none"> <li>• Off: This information will not be printed.</li> <li>• On: The printer prints an image data followed by dump information.</li> <li>• Dump: The printer prints dump information except data dot number.</li> <li>• Print: The printer prints the last dump information. The message [No data] will appear if there is no dump information in the history.</li> </ul>
<b>Spitting</b>	<b>On, Off</b>	With [ON] setting, the printer performs flushing maintenance to prevent nozzle clogging. When set to [OFF], print quality cannot be maintained. Normally this option should be set to [ON].
<b>Pass Count</b>	<b>1 to 999(count)</b>	Specify the interval to perform flushing. The printer performs flushing each time the print head travels left and right the specified number of times. Normally specify [1]. When the multiple number of times is specified, print quality cannot be maintained.

Before Use	
Setup	Key operation
<b>Various Settings</b>	<b>Print settings menu</b>
Basic Operations	Test Print menu
Advanced Operations	Maintenance menu
Maintenance	Printer Status menu
When problems occur	System Information menu
	Ink Agitation menu
Appendix	Sleep Mode menu

Settings menu	Setting range	Functions
<b>Auto Cleaning</b>		Specify the automatic cleaning to be performed while in ready-to-print, before printing or per total printing times.
<b>Standby Mode</b>		
<b>Cleaning Type</b>	<u>Off</u> , Short, Normal, Long	Select the type of automatic cleaning to be performed while in ready-to-print state.
<b>Cleaning Interval</b>	<u>10 min</u> to 1440 min	Set the timer for automatic cleaning to be performed while in ready-to-print state.
<b>Before Print</b>		
<b>Cleaning Type</b>	<u>Off</u> , Short, Normal, Long	Select the type of automatic cleaning to be performed before printing.
<b>Accum. Print Time</b>	<u>Off</u> , 1 hour, 2 hours, 3 hours, 4 hours	Specify the total print time that the printer performs automatic cleaning cycle. The type of cleaning is [Long] (unchangeable).
<b>Multi Layer</b>	<u>Off</u> , On	Select whether or not to enable multi-pass layer printing. The ON setting allows you to print an image over another image on the same media.
<b>Ink Maintenance</b>	Light, <u>Normal</u> , Full	The printer runs automatic ink maintenance which spits out some ink when it is used after a certain period of time from the last use. <ul style="list-style-type: none"> <li>• Normal: Default setting.</li> <li>• Light: Use this mode if you do not usually use white ink for regular printing. This will minimize white ink consumption in ready-to-print state.</li> <li>• Long: This mode performs more powerful ink maintenance than the Normal mode to maintain color consistency. Use this mode when color inconsistencies appear on the print.</li> </ul>

Before Use	
Setup	Key operation
<b>Various Settings</b>	<b>Print settings menu</b>
Basic Operations	Test Print menu
Advanced Operations	Maintenance menu
Maintenance	Printer Status menu
When problems occur	System Information menu
	Ink Agitation menu
Appendix	Sleep Mode menu

Settings menu	Setting range	Functions
<b>Select Nozzle</b>  " <a href="#">Select Nozzle</a> " P.113		If nozzle clogging still persists after several attempts of cleaning, you can check the nozzle conditions by printing the select nozzle patterns and choose only active nozzles for printing.
<b>Print</b>		Print a confirmation patterns and look for a pattern which does not have any missing lines.
<b>Nozzle Area Select</b>	<u>Nozzle ALL</u> , Nozzle A, Nozzle B, Nozzle C, Nozzle D, Nozzle E, Nozzle F	Specify the pattern selected from the confirmation pattern.
<b>Auto Nozzle Check</b>  " <a href="#">Automatic nozzle checking</a> " P.116	<u>Off</u> , <u>On</u>	Select whether to perform automatic nozzle check. In the ON setting, the printer will check the nozzle conditions using the drop sensor and will automatically perform cleaning if nozzle clogs were detected. The printer runs an automatic nozzle check when: <ul style="list-style-type: none"> <li>powering on.</li> <li>waking up from sleep mode.</li> <li>performing the first print after the [Number of print job] setting was specified and each time before printing the specified number of print jobs.</li> </ul> If nozzle clogging still persists after three cleaning attempts, the printer will automatically select a nozzle segment that works properly to continue printing.
<b>Number of print jobs</b>	<u>Off</u> , <u>1 to 30(count)</u>	You can specify the automatic nozzle check cycle by the number of print jobs performed. When specified, the printer will run an automatic nozzle check in the following timing: <ul style="list-style-type: none"> <li>Before performing the first print after this setting was specified.</li> <li>Each time before printing the specified number of jobs.</li> </ul>
<b>Select Nozzle</b>	<u>Off</u> , <u>On</u>	In the ON setting, if there is any missing line in the nozzle check print even after 3 cleanings, the printer will automatically select one nozzle segment that works properly to continue printing.
<b>Ionizer</b> <div style="border: 1px solid green; padding: 5px; margin-top: 10px;">  <b>Note</b>            This menu appears when using the optional ionizer.         </div>	<u>Off</u> , <u>On</u>	In the ON setting, the ionizer removes electrostatics charges from the surface of media.  " <a href="#">Maintenance for optional ionizer</a> " P.211

Before Use	
Setup	Key operation
<b>Various Settings</b>	<b>Print settings menu</b>
Basic Operations	Test Print menu
Advanced Operations	Maintenance menu
Maintenance	Printer Status menu
When problems occur	System Information menu
	Ink Agitation menu
Appendix	Sleep Mode menu



Settings menu	Setting range	Functions
<b>Initial Settings</b>		Select the language and the unit of length to be displayed on the printer control panel and specify IP address and more. For the setup at the first startup, refer to " <a href="#">Configure the initial settings</a> " P.57
Language	<u>English</u> , Dutch, Spanish, French, Italian, Portugese, German, Japanese	Select the language on the printer control panel.
Length	<u>mm</u> , inch	Select the unit of length to be used on the display of the printer control panel.
Remain Ink	Off, <u>On</u>	Select the way to indicate ink levels. <ul style="list-style-type: none"> <li>On: Displays the ink level indicator.</li> <li>Off: Displays the ink slot number that an error occurs (e.g. ink end, ink low, no ink bag).</li> </ul>
IP Address	0.0.0.0 - <u>192.168.1.253</u> - 255.255.255.255	Enter the printer's IP address.
Subnet Mask	0.0.0.0 - <u>255.255.255.0</u> - 255.255.255.255	Enter the printer's subnet mask.
Gateway	0.0.0.0 - <u>192.168.1.254</u> - 255.255.255.255	Enter the printer's gateway.
AlertBuzzer	Off, <u>On</u>	Select how the alert buzzer beeps: <ul style="list-style-type: none"> <li>On: The buzzer beeps continuously.</li> <li>Off: The buzzer beeps only once.</li> </ul>
<b>Initialization</b>		Restore the settings of this printer to the factory defaults.
User All		Reset all the user types.
Advanced Settings		Reset all the settings in [Advanced Settings].
Initial Settings		Reset all the settings in [Initial Settings].
ALL		Reset all the settings in [User Type], [Advanced Settings], [Initial Settings], [Sleep Mode].

Before Use	
Setup	Key operation
<b>Various Settings</b>	<b>Print settings menu</b>
Basic Operations	Test Print menu
Advanced Operations	Maintenance menu
Maintenance	Printer Status menu
When problems occur	System Information menu
Appendix	Ink Agitation menu
	Sleep Mode menu

## User Type

Create your own media preset for each media type (we call it "User Type") and save it with appropriate printer settings as "Type xx". You can define up to 15 user types.

### 1 Go to the User Type menu.

- Tap  Home key → [Menu1 Setup] appears.
- Tap  key twice → [User Type: Type 1] appears.
- Use  key to select a user type between Type 1 and Type 15.

### 2 Tap Enter key and configure various settings.

#### Important !

Changing the user type will change the printer settings to the ones specified for the selected user type.

- Be careful of the print start position if the current user type has different media settings (media height, media size, origin) from the one previously selected and avoid printing on the unintended area or outside the media.

[Detailed-Set: On]

- This menu only appears for the first time the user type is selected when loading media in the printer. For details, see the step 5 of "[Load media](#)" P.72

Before Use	
Setup	Key operation
<b>Various Settings</b>	<b>Print settings menu</b>
Basic Operations	Test Print menu
Advanced Operations	Maintenance menu
Maintenance	Printer Status menu
When problems occur	System Information menu
	Ink Agitation menu
Appendix	Sleep Mode menu

## Adjust Layer Print

Use this menu to adjust layer shifting in layer printing. The following two calibration can be performed:

- Head Fine Adjust: Align ink dot placement between two print heads in single-pass layer printing or multi-pass layer printing. After performing "Head Fine Adjust" calibration, you must perform "Adjust Print" calibration as well. "Head Fine Adjust" calibration only may cause dot placement misalignment.

 ["Adjust Print" calibration" P.88](#)

- Adjust Layer: Adjust layer shifting in multi-pass layer printing when each layer has different drop family setting.

### Adjust Layer Print procedure







1

Load media in the printer.

 ["Load media" P.72](#)

2





Go to the "Adjust Layer Print" menu.

- Tap  Home key → [Menu1 Setup] appears.
- Tap  key twice → [User Type: Type 1] appears.
- Use  /  key to select a user type between Type 1 and Type 15 and tap  Enter key → [Type \*\*:1 Print Mode] appears.
- Tap  key to select [Type \*\*:3 Adj. Layer Prn.].





Before Use	
Setup	Key operation
<b>Various Settings</b>	<b>Print settings menu</b>
Basic Operations	Test Print menu
Advanced Operations	Maintenance menu
Maintenance	Printer Status menu
When problems occur	System Information menu
Appendix	Ink Agitation menu
	Sleep Mode menu

**3** Tap  key and use  /  key to select the calibration method.

**When [Head Fine Adjust] is selected**

- Tap  key. [Head Fine Adjust1 Confirm Pattern] appears.
- Use  /  key to select a confirmation pattern or an adjustment pattern that you want to print and tap  Enter key. The selected pattern will be printed.

**When [Adjust Layer] is selected**

- Tap  key. [Adjust Layer1 Confirm Pattern] appears.
- Use  /  key to select a confirmation pattern or an adjustment pattern that you want to print and tap  key. The selected pattern will be printed.

 **Note**

Tapping  Cancel key while printing a pattern will cancel printing.

**4** Look at the pattern printed and follow these steps to adjust layer shifting.

 ["Head Fine Adjust calibration procedure" P.110](#)

 ["Adjust Layer calibration procedure" P.111](#)

Before Use	
Setup	Key operation
<b>Various Settings</b>	<b>Print settings menu</b>
Basic Operations	Test Print menu
Advanced Operations	Maintenance menu
Maintenance	Printer Status menu
When problems occur	System Information menu
Appendix	Ink Agitation menu
	Sleep Mode menu

## Head Fine Adjust calibration procedure

### 1 Print a Confirm Pattern and check for misalignment.

- If there is misalignment in the pattern, move to the step 2 for calibration. In the example below, the patterns are misaligned.

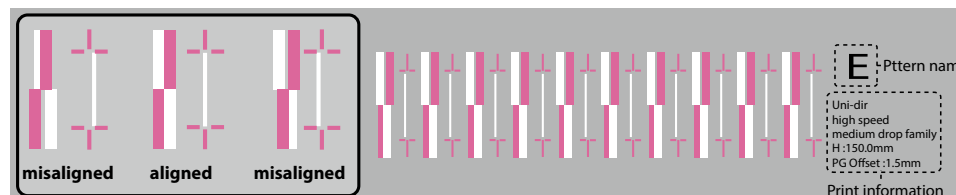

#### Note

The above illustration is an example of pattern E. In this example, the area that no background color is printed is shown in gray.

### 2 Print a fine adjustment pattern (Fine Pattern ALL or Fine Pattern A, B, D, E) and enter a correction value.

- Look at the print. Find the pattern that looks most aligned and mark the number written under the most aligned pattern. (This number is the correction value.)
- The currently selected number is shown in display (like Pattern E: 5). Use / key to enter the number selected and tap Enter key.
- In this example, you will enter [Pattern E: 6].

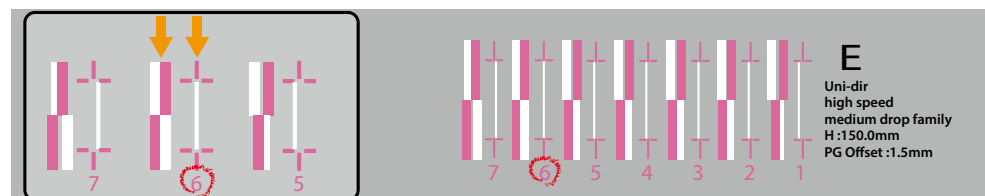

#### Note

After performing "Head Fine Adjust" calibration, you must perform "Adjust Print" calibration as well.

["Adjust Print" calibration" P.88](#)

Before Use	
Setup	Key operation
<b>Various Settings</b>	<b>Print settings menu</b>
Basic Operations	Test Print menu
Advanced Operations	Maintenance menu
Maintenance	Printer Status menu
When problems occur	System Information menu
	Ink Agitation menu
Appendix	Sleep Mode menu

## Adjust Layer calibration procedure

### 1 Print a Confirm Pattern and check for misalignment.

- If there is misalignment in the pattern, move to the next step for calibration. In the example below, the patterns are misaligned.

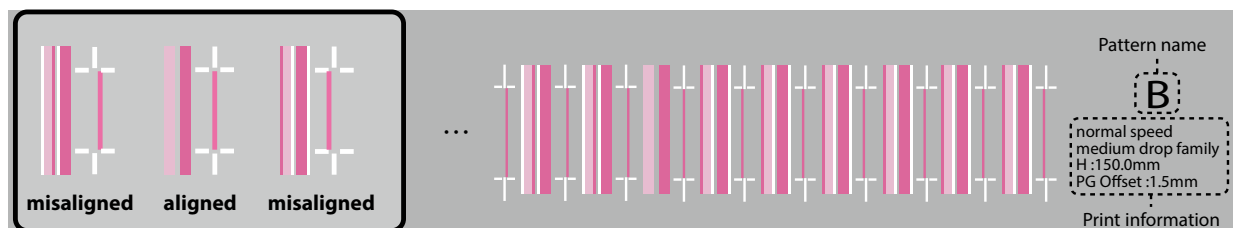

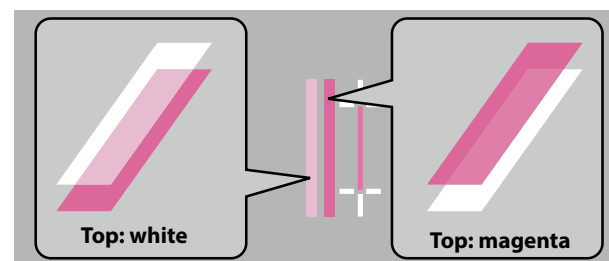

### Note

- The above illustration is an example of pattern B. In this example, the area that no background color is printed is shown in gray.
- Two types of block patterns are printed; left pattern: print white over magenta, right pattern: print magenta over white.





Before Use	
Setup	Key operation
<b>Various Settings</b>	<b>Print settings menu</b>
Basic Operations	Test Print menu
Advanced Operations	Maintenance menu
Maintenance	Printer Status menu
When problems occur	System Information menu
Appendix	Ink Agitation menu
	Sleep Mode menu

## 2 Print a rough adjustment pattern (Rough Pattern ALL or Rough Pattern B, D, E) and enter a correction value.

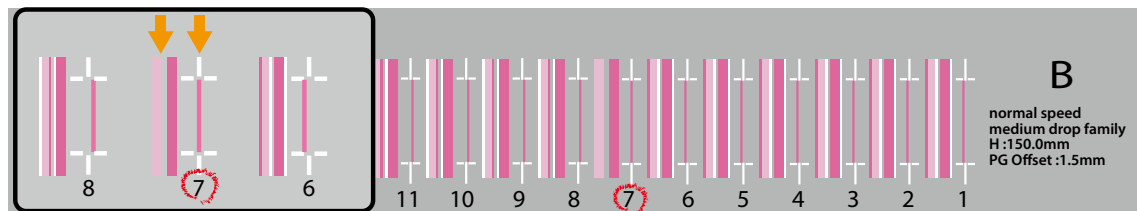
- Look at the print. Find the pattern that looks most aligned and mark the number written under the most aligned pattern. (This number is the correction value.)
- The currently selected number is shown in display (like Pattern B : 6). Use  /  key to enter the number selected and tap  Enter key.
- In this example, you will enter [Pattern B : 7].



## 3 Print a fine adjustment pattern (Fine Pattern ALL or Fine Pattern B, D, E) and enter a correction value.

- Look at the print. Find the pattern that looks most aligned and mark the number written under the most aligned pattern. (This number is the correction value.)
- The currently selected number is shown in display (like Pattern B: 7). Use  /  key to enter the number selected and tap  Enter key.
- In this example, you will enter [Pattern B: 6].

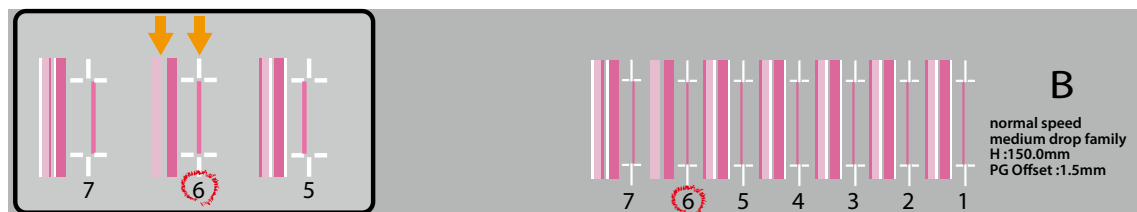

Before Use	
Setup	Key operation
<b>Various Settings</b>	<b>Print settings menu</b>
Basic Operations	Test Print menu
Advanced Operations	Maintenance menu
Maintenance	Printer Status menu
When problems occur	System Information menu
Appendix	Ink Agitation menu
	Sleep Mode menu







## Select Nozzle

If nozzle clogging still persists after several attempts of cleaning, you can check the nozzle conditions by printing a confirmation pattern and choose only active nozzles for printing.

### Print a confirmation pattern

1

Go to the "Select Nozzle" menu.

- Tap  Home key → [Menu1 Setup] appears.
- Tap  key → [Setup1 User Type] appears.
- Use  key to select [Setup2 Advanced Settings].
- Tap  key → [Advanced Settings1 Multi Strike] appears.
- Use  /  key to select [Advanced Settings10 Select Nozzle].

2

Print a confirmation pattern.

- Tap  key.
- [Select Nozzle1 Print] appears. Tap  Enter key. A confirmation pattern will be printed.

Before Use	
Setup	Key operation
Various Settings	Print settings menu
Basic Operations	Test Print menu
Advanced Operations	Maintenance menu
Maintenance	Printer Status menu
When problems occur	System Information menu
Appendix	Ink Agitation menu
	Sleep Mode menu

- 3** Look at the print and find a pattern that all lines are clearly printed.
- In this example, the patterns A, B, D and E have no missing lines.

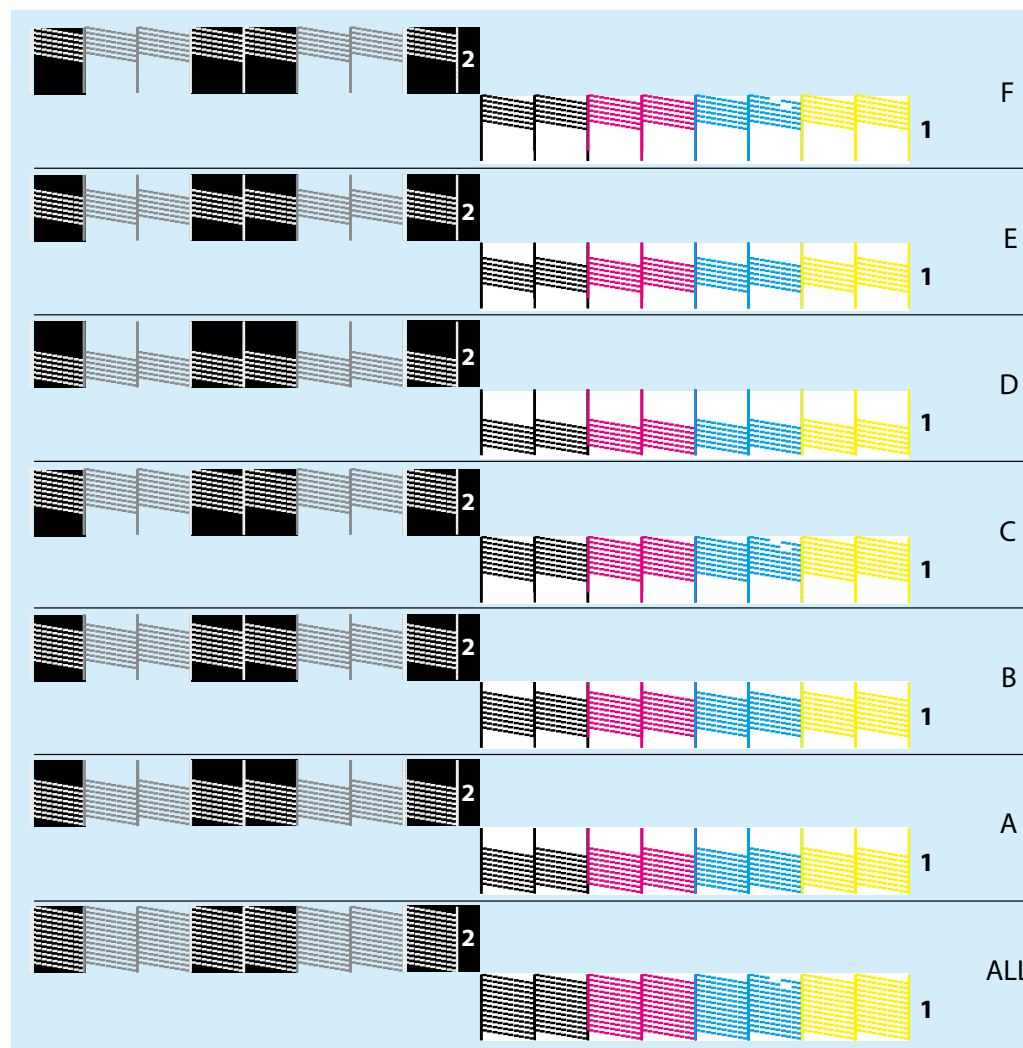



Before Use	
Setup	Key operation
<b>Various Settings</b>	<b>Print settings menu</b>
Basic Operations	Test Print menu
Advanced Operations	Maintenance menu
Maintenance	Printer Status menu
When problems occur	System Information menu
Appendix	Ink Agitation menu
	Sleep Mode menu

## Nozzle Area Select

1

Select the area of active nozzles.

- Go to the [Advanced Settings10 Select Nozzle] menu (step 1 for [Print a confirmation pattern](#)).
- Tap  key → [Select Nozzle1 Select Nozzle 1 Print] appears.
- Tap  key to select [Select Nozzle2 Nozzle Area Select].
- Tap  key.

2

Use  /  key to select the pattern that all lines are clearly printed and tap  Enter key.

- If more than one patterns are clearly printed, select one that has more active nozzles.
- The pattern that has more active nozzles: ALL > A = B = C > D = E = F in order.
- In case of pattern A and pattern D, select pattern A.
- Tap  Enter key.

Before Use	
Setup	Key operation
<b>Various Settings</b>	<b>Print settings menu</b>
Basic Operations	Test Print menu
Advanced Operations	Maintenance menu
Maintenance	Printer Status menu
When problems occur	System Information menu
	Ink Agitation menu
Appendix	Sleep Mode menu

## Automatic nozzle checking

In case the printer is used in a place other than recommended environment (" Specifications" P.261 ) or depending on the ink being used, the following phenomenon may appear:

- The printer performs cleaning cycle each time an automatic nozzle check is run.
  - Automatic nozzle checking takes more time.
  - Even if an automatic nozzle checking was performed, nozzle clogging appears on the print. (\*)
- \*If nozzle clogging persists, manually run a nozzle check and cleaning.

☞ " Nozzle Check" P.118 , " Head cleaning" P.204

This function does not guarantee 100 percent prevention of nozzle clogging.







### Enable "Auto Nozzle Check"

The automatic nozzle checking function regularly monitors nozzle clogging with the drop sensor without wasting media. In case the sensor detects nozzle clogs, the printer performs an automatic cleaning to continue printing or automatically selects active nozzles to continue printing.

Tapping  Cancel key while an automatic nozzle checking is being performed will cancel nozzle checking.

1

Go to the "Auto Nozzle Check" menu.

- Tap  Home key → [Menu1 Setup] appears.
- Tap  key → [Setup1 User Type] appears.
- Use  key to select [Setup2 Advanced Settings].
- Tap  key → [Advanced Settings1 Multi Strike] appears.
- Use  /  key to select [Advanced Settings11 Auto Nozzle Check].

2

Set the Auto Nozzle Check to ON.

- Tap  key.
- Select [Auto Nozzle Check On] and tap  Enter key.

Before Use	
Setup	Key operation
<b>Various Settings</b>	<b>Print settings menu</b>
Basic Operations	Test Print menu
Advanced Operations	Maintenance menu
Maintenance	Printer Status menu
When problems occur	System Information menu
	Ink Agitation menu
Appendix	Sleep Mode menu

## Automatic nozzle checking flow

### Note

Normally the detection takes about 3 to 5 minutes, but it may take longer according to the number of clogged nozzles.

1

### When nozzle cloggings were detected

- [Cleaning \*\*%] appears and the printer runs an automatic cleaning to clear nozzles.
- In case the print head is selected in the Cleaning menu, cleaning is performed on the selected print head only.
- Cleaning cycle to be performed is up to three times.

2

### When the active nozzle area was automatically selected

- In case nozzle clogging persists after two cleaning attempts, the printer automatically selects an active nozzle area to be able to continue printing with properly firing nozzles.
- When the printer becomes ready to print, the message [Print Ready H : XXX.Xmm Nozzle:\*] will appear with the selected nozzle area (\*).

3

### In case nozzle clogging still persists

- The message [Auto Nozzle Check Nozzle Clog Present] appears. If the print job has already been sent to the printer, the job that nozzle clogging was detected will be deleted and the rest of the print jobs will be on hold.
- To clear nozzle clogging, delete the job being on hold using the computer that you sent the job, then manually run a nozzle check and cleaning. MUTOH recommends you to clear the nozzles and print the job again.

 [" Nozzle Check" P.118](#) , [" Head cleaning" P.204](#)

- In case you need to print the job being on hold without clearing nozzles, tap  Enter key.

Before Use	
Setup	Key operation
<b>Various Settings</b>	Print settings menu
Basic Operations	<b>Test Print menu</b>
Advanced Operations	Maintenance menu
Maintenance	Printer Status menu
When problems occur	System Information menu
Appendix	Ink Agitation menu
	Sleep Mode menu

# Test Print menu

Menu	Functions
Nozzle Check	Prints a nozzle check pattern using the nozzles selected from the "Select Nozzle" menu. ☞ " For "Nozzle Check" pattern" P.80
Nozzle Check F	Prints a nozzle check pattern using all nozzles. ☞ " For "Nozzle Check F" pattern" P.79
Nozzle Check B	The nozzle check patterns of the white and color inks will be printed with the background colors so that the nozzle conditions of these colors can be easily observed. ☞ " For "Nozzle Check B" pattern" P.81
Nozzle Check L	Prints a nozzle check pattern by placing a paper at the left vacant space on the printer. A nozzle check pattern can be printed without removing media placed on the vacuum table. ☞ " For "Nozzle Check L" pattern" P.82
Mode Print	Tapping  Enter key will print the following settings specified in the currently selected user type: Print mode/ Effect option/ Micro adjustment value of PF Adjust (Required media size: width 220 mm x length 25 mm)  <div style="border: 1px solid black; padding: 5px; text-align: right; margin-top: 20px;">2023/01/01 0:00 Quality i-Weave UVEx / PF Adjust: 0.00%</div>

Before Use

Setup

Various Settings

Basic Operations

Advanced Operations

Maintenance

When problems occur

Appendix

Key operation

Print settings menu

Test Print menu

Maintenance menu

Printer Status menu

System Information menu

Ink Agitation menu

Sleep Mode menu

### Menu

#### Setup List

### Functions



Tapping  Enter key will print the settings configured in the printer and specified in each user type.

(Required media size: width 420 mm x length 297 mm)



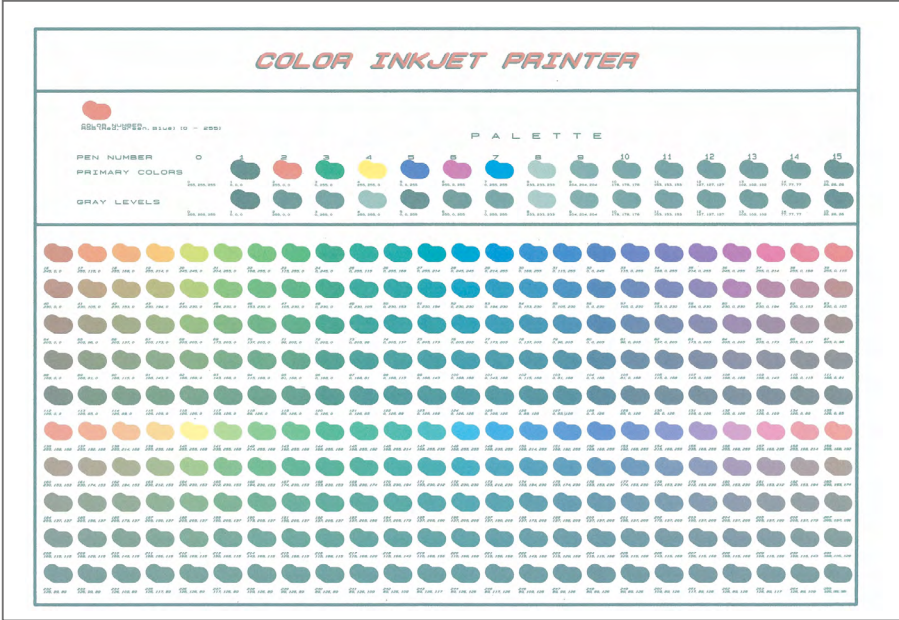

Menu		Status
<b>Setup List</b>		
K Information		
Serial No. = K05U00001 Total Print Area = 1000H		
Model = 3711xxxxx Firmware M = V1.00		
Memory Size = 32xxx Firmware C = V1.00		
2024/01/01 00:00		
[Number]Menu - Setup		
[1]User Type = Type 1	[2]Test Print	[3]PF Adj. Unit
[1]Print Mode = Production (2250*1-Weave UVE)	[2]Initial Change = 500 of 500mm	[2]Micro Change = -0.01h
[2]Adjust Print	[3]Maintenance	[1]Cleaning
[3]Select Layer Print	[2]CR Maintenance	[2]CR Maintenance
[4]Media Setting	[3]UV Scan	[3]UV Scan
[1]Set Media	[1]Start	[2]Number of UV Scan = 4
[2]Size Width = 1420mm Length = 700mm	[4]Ink Discharge	[5]Purge Life
[3]Height = Auto (PG Offset = 0.0mm)	[5]Confirm	Slot1: E***** Slot2: E***** Slot3: E*****
[4]Origin PF = 0.0mm CR = 0.0mm	[2]Initialization	[2]Initialization
[5]Detailed-Set = Off	[6]Back Cleaning	[7]Daily Maintenance
[6]Low Speed = Off	[7]Daily Maintenance	[8]Ink Level
[6]Obstacle Detect = Auto	[4]Printer Status	[1]Ink
[7]Copy User Type	[1]Ink	Head1 123456 Head2 100/100/100/100/100/100
[8]Initialization	[2]Life Times	CR Motor E***** PF Motor E*****
[1]Multi Strike = Test	[3]Job Status	PG Motor L E***** PG Motor R E*****
Layer Multi Strike	[4]Total Print Area	Pump1 E***** Pump2 E*****
[1]Color Layer = Test	[5]Ink expiration	UV Lamp L E***** UV Lamp R E*****
[2]White Layer = Test	Slot1: 2024/12/31 Slot2: 2024/12/31	Dust Cover1 E***** Dust Cover2 E*****
[3]Vertical Layer = Test	Slot3: 2024/12/31 Slot4: 2024/12/31	Dust Cover3 E***** Dust Cover4 E*****
[4]Pass Wait = 0.0sec	[5]System Info	[1]Perform
[3]Head Travel = Media	[1]Next Time	[2]Next Time
[4]Heater Dump = Off	[2]Next Time	MODE: 48h
[5]Splitting = On (Pass Count = 1Cnt)	[3]W : C1h	[3]20*Send
[6]Auto Cleaning	[1]Start	[2]Cleaning Timer
[1]Standby Mode = Off	[2]Cleaning Timer	CleaningType = Off
[2]Rafara Print = Off	CleaningTime = 1h	
[3]Accum. Print Time = Off		
[7]Multi Layer = Off		
[8]Ink Maintenance = Normal		
[9]Select Nozzle		
[1]Print		
[2]Nozzle Area Select = Nozzle ALL		
[10]Auto Nozzle Check = On		
[1]Number of print job = 30cnt		
[2]Select Nozzle = On		
[1]Ink Level		
[2]Initial Settings		
[1]Language = English		
[2]Language = mm		
[3]Remain Ink = 0		
[4]IP Address = 192.168.1.255		
[5]Subnet Mask = 255.255.255.255		
[6]Gateway = 192.168.1.254		
[7]Start Buzzer = On		

User Type List					
User Type	Type 1	Type 2	Type 3	Type 4	Type 5
Print Mode	Production	Production	Production	Production	Production
Print Mode/Effect	-Weave UVE	-Weave UVE	-Weave UVE	-Weave UVE	-Weave UVE
Media>Size	1420mm	1420mm	1420mm	1420mm	1420mm
Media>Length	700mm	700mm	700mm	700mm	700mm
Media>Height	Auto (PG Offset = 0.0mm)	Auto (PG Offset = 0.0mm)	Auto (PG Offset = 0.0mm)	Auto (PG Offset = 0.0mm)	Auto (PG Offset = 0.0mm)
Media>Origin	PF = 0.0 CR = 0.0	PF = 0.0 CR = 0.0	PF = 0.0 CR = 0.0	PF = 0.0 CR = 0.0	PF = 0.0 CR = 0.0
Media>Detailed-Set	Off	Off	Off	Off	Off
Low Speed	Off	Off	Off	Off	Off
Obstacle Detect	Auto	Auto	Auto	Auto	Auto
User Type	Type 6	Type 7	Type 8	Type 9	Type 10
Print Mode	Production	Production	Production	Production	Production
Print Mode/Effect	-Weave UVE	-Weave UVE	-Weave UVE	-Weave UVE	-Weave UVE
Media>Size	1420mm	1420mm	1420mm	1420mm	1420mm
Media>Length	700mm	700mm	700mm	700mm	700mm
Media>Height	Auto (PG Offset = 0.0mm)	Auto (PG Offset = 0.0mm)	Auto (PG Offset = 0.0mm)	Auto (PG Offset = 0.0mm)	Auto (PG Offset = 0.0mm)
Media>Origin	PF = 0.0 CR = 0.0	PF = 0.0 CR = 0.0	PF = 0.0 CR = 0.0	PF = 0.0 CR = 0.0	PF = 0.0 CR = 0.0
Media>Detailed-Set	Off	Off	Off	Off	Off
Low Speed	Off	Off	Off	Off	Off
Obstacle Detect	Auto	Auto	Auto	Auto	Auto
User Type	Type 11	Type 12	Type 13	Type 14	Type 15
Print Mode	Production	Production	Production	Production	Production
Print Mode/Effect	-Weave UVE	-Weave UVE	-Weave UVE	-Weave UVE	-Weave UVE
Media>Size	1420mm	1420mm	1420mm	1420mm	1420mm
Media>Length	700mm	700mm	700mm	700mm	700mm
Media>Height	Auto (PG Offset = 0.0mm)	Auto (PG Offset = 0.0mm)	Auto (PG Offset = 0.0mm)	Auto (PG Offset = 0.0mm)	Auto (PG Offset = 0.0mm)
Media>Origin	PF = 0.0 CR = 0.0	PF = 0.0 CR = 0.0	PF = 0.0 CR = 0.0	PF = 0.0 CR = 0.0	PF = 0.0 CR = 0.0
Media>Detailed-Set	Off	Off	Off	Off	Off
Low Speed	Off	Off	Off	Off	Off
Obstacle Detect	Auto	Auto	Auto	Auto	Auto

Before Use	
Setup	Key operation
Various Settings	Print settings menu
Basic Operations	<b>Test Print menu</b>
Advanced Operations	Maintenance menu
Maintenance	Printer Status menu
When problems occur	System Information menu
Appendix	Ink Agitation menu
	Sleep Mode menu

Menu	Functions
<b>Palette</b>	Tapping  Enter key will print a color palette of the printer. (Required media size: width 297 mm x length 210 mm)  
<b>Adjust Head</b>  <b>"Adjust Head" calibration"</b> <b>P.85</b>	Print an "Adjust Head" pattern pattern and align ink dot placement between two print heads.
<b>Standard</b>	Align ink dot placement for the selected print mode.
<b>Custom</b>	<b>Fine Pattern ALL, Fine Pattern A,B,D,E</b> Align dot placement for all the printing conditions that can be changed in the RIP software.

Before Use	
Setup	Key operation
<b>Various Settings</b>	Print settings menu
Basic Operations	<b>Test Print menu</b>
Advanced Operations	Maintenance menu
Maintenance	Printer Status menu
When problems occur	System Information menu
Appendix	Ink Agitation menu
	Sleep Mode menu

Menu		Functions
<b>PF Adjust</b> ☞ " Gantry feed adjustment (PF Adjust)" P.122		Print an "Initial Print" pattern and adjust the gantry feed amount.
<b>Initial Print</b>	<b>100mm to 500mm to 650mm</b>	Print an "Initial Print" pattern. Enter the amount the gantry feeds in Feed Length and tap  Enter key.
<b>Initial Change</b>	<b><u>the length entered in Initial Print</u> ±10.0mm</b>	
<b>Confirm Print</b>	<b>100mm to 500mm to 650mm</b>	Print a "Confirm Print" pattern. Enter the amount the gantry feeds in Feed Length and tap  Enter key.
<b>Micro Print</b>	<b>0%, ±0.1%, ±0.2%, ±0.5%, 7 patterns</b>	Print a "Micro Print" pattern and find the micro adjustment value from the printed patterns.
<b>Micro Change</b>	<b>-5.00% to <u>0.00%</u> to 5.00%</b>	Use  /  key to enter the micro adjustment value and tap  Enter key.

Before Use	
Setup	Key operation
<b>Various Settings</b>	Print settings menu
Basic Operations	<b>Test Print menu</b>
Advanced Operations	Maintenance menu
Maintenance	Printer Status menu
When problems occur	System Information menu
Appendix	Ink Agitation menu
	Sleep Mode menu

## Gantry feed adjustment (PF Adjust)





Use this menu to adjust the gantry feed amount.

When the following problem happens, try this adjustment. It could help.





- Images are overlapping.
- White lines appear on the image.

### Procedure

#### 1 Go to the "PF Adjust" menu.

- Tap  Home key → [Menu1 Setup] appears.
- Use  key to select [Menu2 Test Print].
- Tap  key → [Test Print1 Nozzlecheck] appears.
- Use  /  key to select [Test Print9 PF Adjust].

#### 2 Print an "Initial Print" pattern.

- Tap  key → [PF Adjust1 Initial Print] appears.
- Tap  key → [Initial Print FeedLength] appears.
- Use  /  key to enter the gantry feed length and tap  Enter key.

Before Use	
Setup	Key operation
<b>Various Settings</b>	Print settings menu
Basic Operations	<b>Test Print menu</b>
Advanced Operations	Maintenance menu
Maintenance	Printer Status menu
When problems occur	System Information menu
Appendix	Ink Agitation menu
	Sleep Mode menu

3

Measure the distance between two "+" marks with a ruler.

- In this example, the distance you will measure is shown with the blue arrow between two dotted lines. (The blue arrow and dotted lines will not be printed)

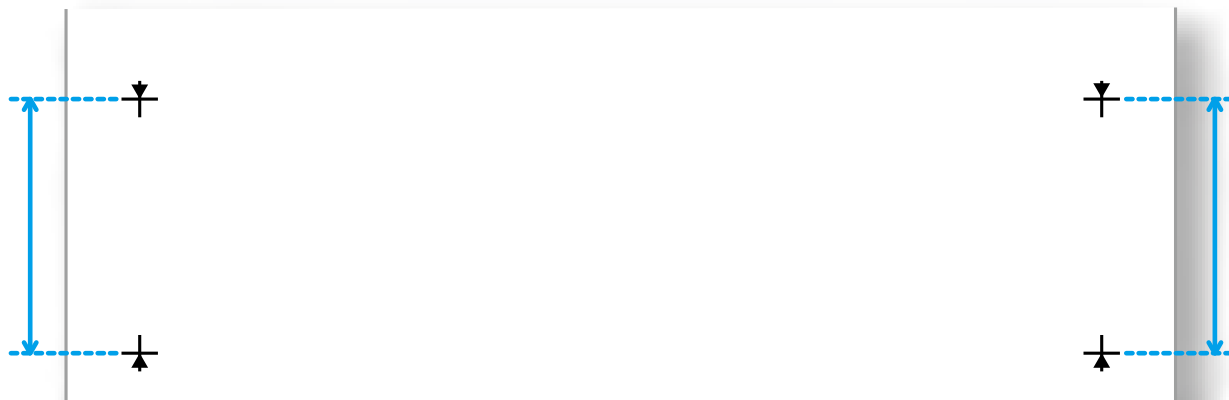

**Note**

- The maximum length you can enter in Feed Length varies by the media length specified in [Media Setting] > [Size] > [Length]. (This also applies to Confirm Print)
- Initial Print cannot be performed depending on the media size. For example, if the media length is less than 100 mm, an error message "Outside Print Area" will appear and you will not be able to print a pattern.







4

Enter the measured distance.

- Go to [Test Print9 PF Adjust] (step 1) and tap key → [PF Adjust1 Initial Print] appears.
- Use key to select [PF Adjust2 Initial Change] and tap key.
- Use / key to enter the measured value and tap Enter key. This will be the initial adjustment value.

Before Use	
Setup	Key operation
<b>Various Settings</b>	Print settings menu
Basic Operations	<b>Test Print menu</b>
Advanced Operations	Maintenance menu
Maintenance	Printer Status menu
When problems occur	System Information menu
Appendix	Ink Agitation menu
	Sleep Mode menu

**5** Print a "Confirm Print" pattern.

- Go to [Test Print9 PF Adjust] (step 1) and tap  key → [PF Adjust1 Initial Print] appears.
- Use  key to select [PF Adjust3 Confirm Print] and tap  key → [Confirm Print: FeedLength] appears.
- Use  /  key to enter the gantry feed length and tap  [Enter] key.

**6** Measure the distance between two "+" marks with a ruler.

- If the measured distance is different from the feed length you entered, go back to step 1 to do the adjustment again. If the measured distance matches the feed length, move to step 7.
- In this example, the distance you will measure is shown with the blue arrow between two dotted lines. (The blue arrow and dotted lines will not be printed)

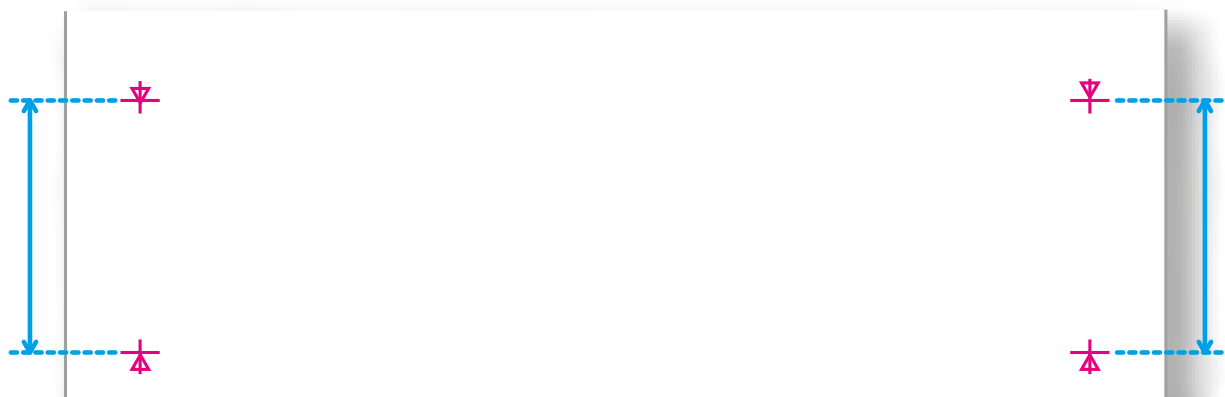

Before Use	
Setup	Key operation
<b>Various Settings</b>	Print settings menu
Basic Operations	<b>Test Print menu</b>
Advanced Operations	Maintenance menu
Maintenance	Printer Status menu
When problems occur	System Information menu
Appendix	Ink Agitation menu
	Sleep Mode menu

## 7

Print a "Micro Print" pattern. Look at the print and enter the micro adjustment value.

- Go to [Test Print9 PF Adjust] (step 1) and tap key → [PF Adjust1 Initial Print] appears.
- Use key to select [PF Adjust4 Micro Print] and tap Enter key.
- Look at the print and find the pattern that has the least overlapping or white lines. The number written under the pattern is the micro adjustment value.

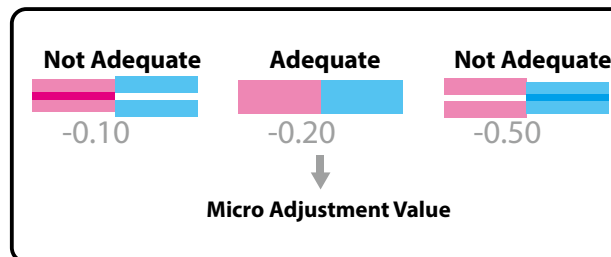

## 8

Enter the micro adjustment value.

- Go to [Test Print9 PF Adjust] (step 1) and tap key → [PF Adjust1 Initial Print] appears.
- Use key to select [PF Adjust5 Micro Change] and tap key → [Micro Change (-5 - 5) 0.00%] appears.
- Use / key to enter the micro adjustment value and tap Enter key.

### Note

The micro adjustment value saved will be the reference value in the pattern from the next time. For example, if you saved [-0.20] here, the number to be printed in the center of the patterns from the next time will be changed to [-0.20] and the number of the left most pattern will be [+1.00] and the number of the right most pattern will be [-1.40].

Before Use

Setup

Various Settings

Basic Operations

Advanced Operations

Maintenance

When problems occur

Appendix

Key operation

Print settings menu

Test Print menu

Maintenance menu

Printer Status menu

System Information menu

Ink Agitation menu

Sleep Mode menu

# Maintenance menu

Settings menu	Settings range	Functions						
<b>Cleaning</b> <b>" Head cleaning" P.204</b>		After selecting the print head and the types of cleaning, tapping  Enter key will begin cleaning.						
<table border="1"> <tr> <td>Select Print Head</td> <td>ALL, Head1, Head2</td> <td>Select the print head.</td> </tr> <tr> <td>Cleaning Type</td> <td>Short, Normal, Long, Little Charge, Initial Charge</td> <td>Select the type of cleaning. (The [Initial Charge] option will not be displayed when [Head1] or [Head2] is selected.)</td> </tr> </table>	Select Print Head	ALL, Head1, Head2	Select the print head.	Cleaning Type	Short, Normal, Long, Little Charge, Initial Charge	Select the type of cleaning. (The [Initial Charge] option will not be displayed when [Head1] or [Head2] is selected.)		
Select Print Head	ALL, Head1, Head2	Select the print head.						
Cleaning Type	Short, Normal, Long, Little Charge, Initial Charge	Select the type of cleaning. (The [Initial Charge] option will not be displayed when [Head1] or [Head2] is selected.)						
<b>CR Maintenance</b> <b>" Replacing consumable parts" P.218</b>		Use this menu when you replace consumable parts. By tapping  Enter key on the message [Start ->Enter], the carriage will move to the maintenance position. <b>" Replace the flushing box pad" P.220</b> <b>" Replace the cleaning wiper" P.224</b> <b>" Replace the emitting window glass of the UV-LED lamp" P.227</b> <b>" Replace the filter of UV-LED lamp" P.230</b>						
<b>UV Scan</b> <b>" UV Scan" P.128</b>		This menu performs post curing with UV light. Use this menu when extra UV curing is required after printing (such as insufficient curing due to errors).						
<table border="1"> <tr> <td>Start</td> <td></td> <td>Tapping  Enter key will perform UV curing.</td> </tr> <tr> <td>Number of UV Scan</td> <td>2, 4, 8, 16</td> <td>Select the number of times the UV scanning is performed per inch in the front-back direction.</td> </tr> </table>	Start		Tapping  Enter key will perform UV curing.	Number of UV Scan	2, 4, 8, 16	Select the number of times the UV scanning is performed per inch in the front-back direction.		
Start		Tapping  Enter key will perform UV curing.						
Number of UV Scan	2, 4, 8, 16	Select the number of times the UV scanning is performed per inch in the front-back direction.						
<b>Ink Discharge</b>		If the printer will not be used for a long period of time, use this menu to flush the ink out of the printer. <b>" When not using the printer for a long period of time" P.236 , " 2. Flush ink out of printer" P.237</b>						

Before Use	
Setup	Key operation
<b>Various Settings</b>	<b>Print settings menu</b>
Basic Operations	Test Print menu
Advanced Operations	<b>Maintenance menu</b>
Maintenance	Printer Status menu
When problems occur	System Information menu
Appendix	Ink Agitation menu
	Sleep Mode menu

Settings menu	Settings range	Functions
<b>Plug Lifetime</b> ☞ " Replace the adapter's plug for high-capacity ink pack adapter" P.188		Use this menu to check and replace the plug for high-capacity ink pack adapter.
<b>Confirm</b>		Use this menu to check the remaining life of the adapter's plug on the high-capacity ink pack adapter. <ul style="list-style-type: none"> <li>The remaining life of the plug is indicated by the asterisks (Maximum 5 asterisks: 100% left). As the part deteriorates, the number of asterisks decreases one by one (20%).</li> <li>The plug must be replaced when all of the asterisks have disappeared and "Change" is displayed.</li> </ul>
<b>Initialization</b>		Reset the life counter of an adapter plug after replacing it. Select an appropriate ink slot and reset the counter.
<b>Soak Cleaning</b> ☞ " Soak Cleaning" P.206		Soak the print head in the maintenance cleaner filled in the head cap to clean dirt on the surface of nozzle. Perform a soak cleaning if nozzle clogging still persists after head cleaning attempt.
<b>Daily Maintenance</b> ☞ " Daily maintenance at the end of work" P.193 ☞ " Cleaning each part of the printer" P.209		Use this menu to run a daily maintenance. By tapping  Enter key on the message [Start ->Enter], the gantry and the carriage will move to the maintenance position.
<b>Ionizer</b>		Use this menu to check if the ionizer is working properly. ☞ " Maintenance for optional ionizer" P.211 ☞ " Warning indicator light function" P.216





Before Use	
Setup	Key operation
<b>Various Settings</b>	Print settings menu
Basic Operations	Test Print menu
Advanced Operations	<b>Maintenance menu</b>
Maintenance	Printer Status menu
When problems occur	System Information menu
Appendix	Ink Agitation menu
	Sleep Mode menu

## UV Scan

Use this menu when extra UV curing is required after printing (such as insufficient curing due to errors).



1

Go to the "UV Scan" menu.



- Tap  Home key → [Menu1 Setup] appears.
- Use  key to select [Menu3 Maintenance].
- Tap  key → [Maintenance1 Cleaning] appears.
- Use  key to select [Maintenance3 UV Scan].

2







Perform an extra curing by UV light.

- Tap  key → [UV Scan1 Start] appears.
- Tap  key → [UV Scan Start->Enter] appears.
- Tap  Enter key.

### Note

- The area where UV curing is performed depends on the settings of [Media Setting] - [Size] and [Origin] for the currently selected user type.
- If  Cancel key is tapped during UV curing, the message [Curing Cancel? -> Enter] will appear. To cancel UV curing, tap  Enter key. To return to the previous display, tap  Home key.

You can specify the number of times the UV scanning is performed per inch in the front-back direction.

- Go to the [Maintenance3 UV Scan] menu (step 1) and tap  key → [UV Scan Start] will appear.
- Use  key to select [UV Scan2 Number of UV Scan].
- Tap  key.
- Use  /  key to specify the number of times and tap  Enter key.

Before Use

Setup

Various Settings

Basic Operations

Advanced Operations

Maintenance

When problems occur

Appendix

Key operation

Print settings menu

Test Print menu

Maintenance menu



Printer Status menu

System Information menu

Ink Agitation menu

Sleep Mode menu

# Printer Status menu

Settings menu	Settings range	Functions
Ink		<p>Displays the ink level in percentage per ink slot.</p> <div style="border: 1px solid green; padding: 5px;"> <p> <b>Note</b></p> <p>If the ink level blinks at 10 percent, the smartchip recovery is being performed on the corresponding ink.</p> <p> <a href="#">" Smartchip recovery" P.249</a></p> </div>
Life Times	Head 1, Head 2, CR Motor, PF Motor, PG Motor L, PG Motor R, Pump 1, Pump 2, Circulation Pump, UV lamp L, UV lamp R, Dust Cover	<p>Displays remaining life of the parts that need to be replaced.</p> <ul style="list-style-type: none"> <li>The remaining life is indicated by the asterisks (Maximum 5 asterisks: 100% left). As the part deteriorates, the number of asterisks decreases one by one (20%).</li> <li>The part must be replaced when all of the asterisks have disappeared and [Change] is displayed.</li> </ul>
Job Status		
Job Status		If printing is complete, [Completed] will be displayed. If printing is cancelled, [Cancelled] will be displayed.
ToDoLength		Displays the length of the print data.
Done		Displays the length printed.
Remain		Displays the length of data which has not been printed yet.
Total Print Area		Displays the total printed area.
Ink expiration		<p>Displays ink expiration date.</p> <ul style="list-style-type: none"> <li>This menu appears only when using US61 ink.</li> <li>"----/--/--" is displayed for the slot where the smartchip recovery is being performed.</li> </ul> <p> <a href="#">" Smartchip recovery" P.249</a></p>

Before Use	
Setup	Key operation
<b>Various Settings</b>	<b>Print settings menu</b>
Basic Operations	Test Print menu
Advanced Operations	Maintenance menu
Maintenance	Printer Status menu
When problems occur	<b>System Information menu</b>
Appendix	Ink Agitation menu
	Sleep Mode menu

# System Information menu

Settings menu	Functions
Version	Displays the firmware version installed on the printer.
Printer Model	Displays the printer model name.
Serial Number	Displays the serial number of the printer.
Ink Type	Displays the ink type loaded on the printer.

Before Use	
Setup	Key operation
<b>Various Settings</b>	Print settings menu
Basic Operations	Test Print menu
Advanced Operations	Maintenance menu
Maintenance	Printer Status menu
When problems occur	System Information menu
Appendix	<b>Ink Agitation menu</b>
	Sleep Mode menu

# Ink Agitation menu

This menu allows you to immediately perform ink agitation or check the time until the next ink agitation is required.

Submenu	Functions
Perform	Select an ink and agitate it. ☞ "Agitating ink" P.172
Next time	Displays the time until the next ink agitation is required. ☞ "Agitating ink" P.172

Before Use	
Setup	Key operation
<b>Various Settings</b>	<b>Print settings menu</b>
Basic Operations	Test Print menu
Advanced Operations	Maintenance menu
Maintenance	Printer Status menu
When problems occur	System Information menu
Appendix	Ink Agitation menu
	<b>Sleep Mode menu</b>

# Sleep Mode menu

Settings menu	Settings range	Functions
Sleep Mode menu		Put the printer into sleep mode. Follow the instructions on the panel to perform a daily maintenance when entering to sleep mode. ☞ "Sleep Mode" P.145 ☞ "Daily maintenance at the end of work" P.193
Cleaning Timer		Set the timer of automatic head cleaning to be performed while in sleep mode.
Cleaning Type	Off, Short, Normal, Long	Select the type of automatic cleaning to be performed while in sleep mode.
Cleaning Timer	1, 2, 3, 4, 5, 6, 9, 12, 18, 24(hour)	Set the timer for automatic cleaning to be performed while in sleep mode.

# Basic Operations

**Printing** 134

**Sleep Mode** 145

**Stop the printer for emergency** 147

Before Use

Setup

Various Settings

Basic Operations

Advanced Operations

Maintenance

When problems occur

Appendix

Printing

Sleep Mode

Stop the printer for emergency

# Printing

## Printable area

- You will need to enter the size of media (width and length) loaded on the table.
- The default origin position (print start position) is the front right end of the table. You can change the origin position depending on where media is placed.
- The guide line shows the maximum printable area (1420 mm x 700 mm).
- The screw holes (M4) can be used for mounting your personal jig.
- For each dimension, see Vacuum Table dimensions.

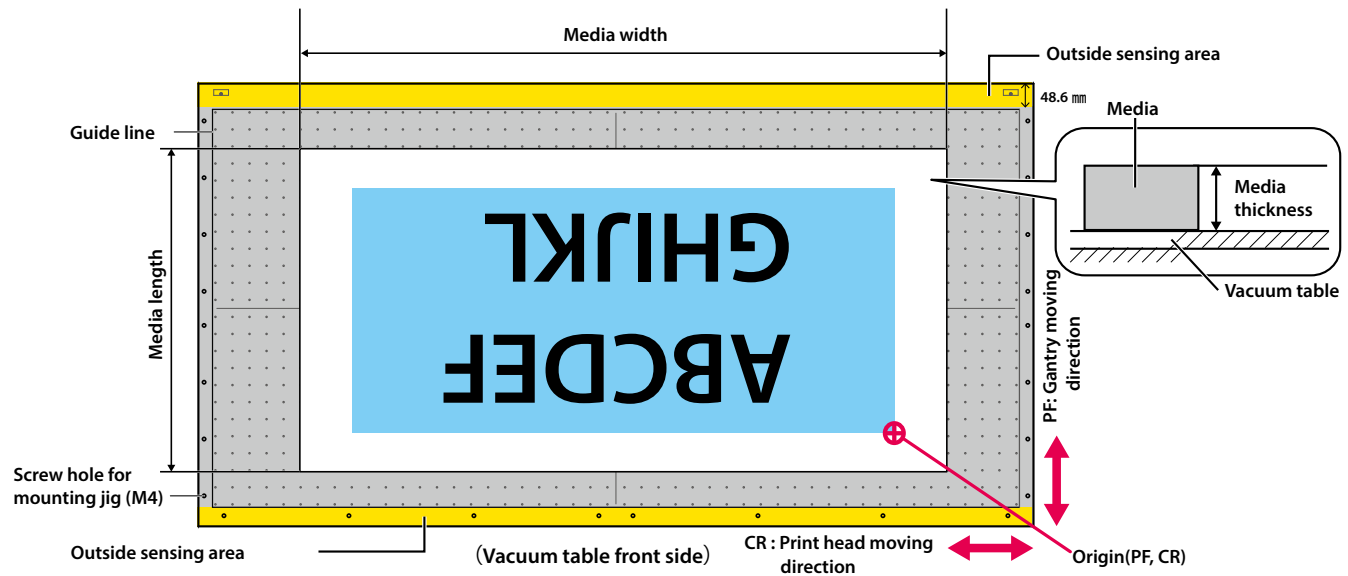

### Important!

The area in front of the guide line on the front side of the table is outside the sensing area of the media height detector. Any object (including jig) which is higher than the media placed on the table should not be placed here. This will cause the print head to strike it.

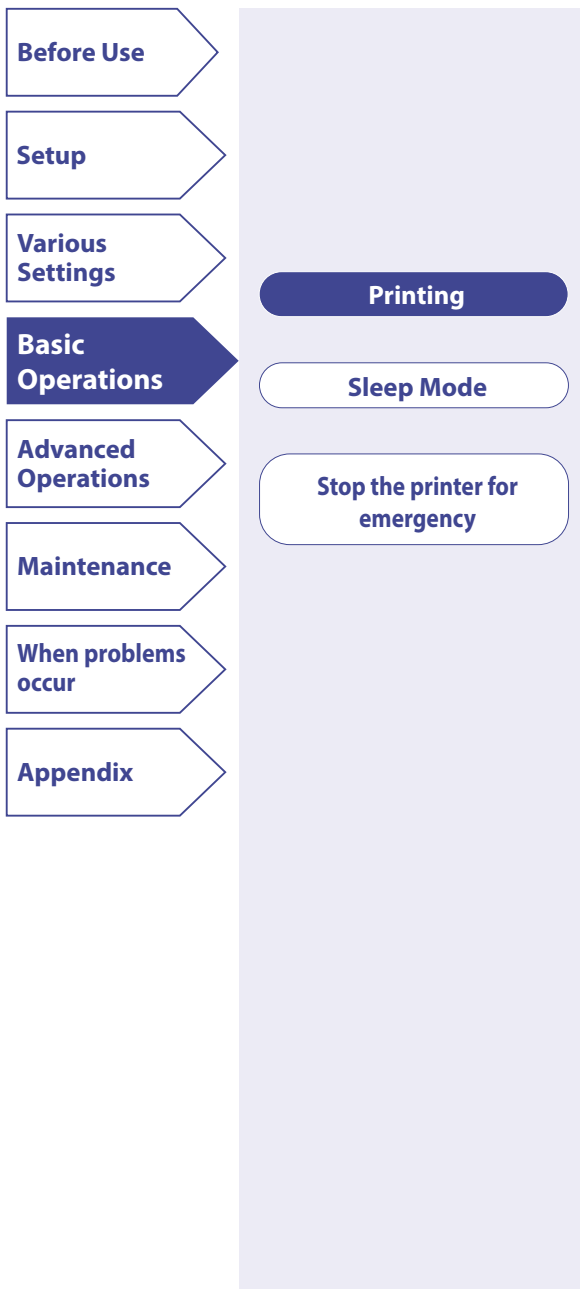

## Printing workflow

The following is the basic operation flow for printing.

- 1 Load media on the table.**  
☞ ["Load media" P.72](#)
- 2 Run a nozzle check (perform cleaning if needed).**  
☞ ["Run a nozzle check and cleaning" P.78](#)
- 3 Perform print head and bidirectional calibrations (if needed).**  
☞ ["Perform print head and bidirectional calibrations" P.85](#)
- 4 Print a design.**
  - We will introduce the printing procedure using MUTOH RIP software "VerteLith".  
☞ ["Start printing" P.136](#)  
☞ ["Advanced Operations" P.150](#)
- 5 End the printing operation.**  
☞ ["Daily maintenance at the end of work" P.193](#)

Before Use

Setup

Various Settings

Basic Operations

Advanced Operations

Maintenance

When problems occur

Appendix

Printing

Sleep Mode

Stop the printer for emergency

## Start printing

Here we will explain the basic printing procedure (a single layer printing) using VerteLith.

For more details of VerteLith setup and operation, see the VerteLith user manual.

1

Before printing, do the following in order:

- ☞ "Load media" P.72
- ☞ "Run a nozzle check and cleaning" P.78
- ☞ "Perform print head and bidirectional calibrations" P.85 (if needed)

2

Start VerteLith. Select "XPJ-1462UF" from the list of printer (①)

- [XPJ1462UF] will appear. (②)。

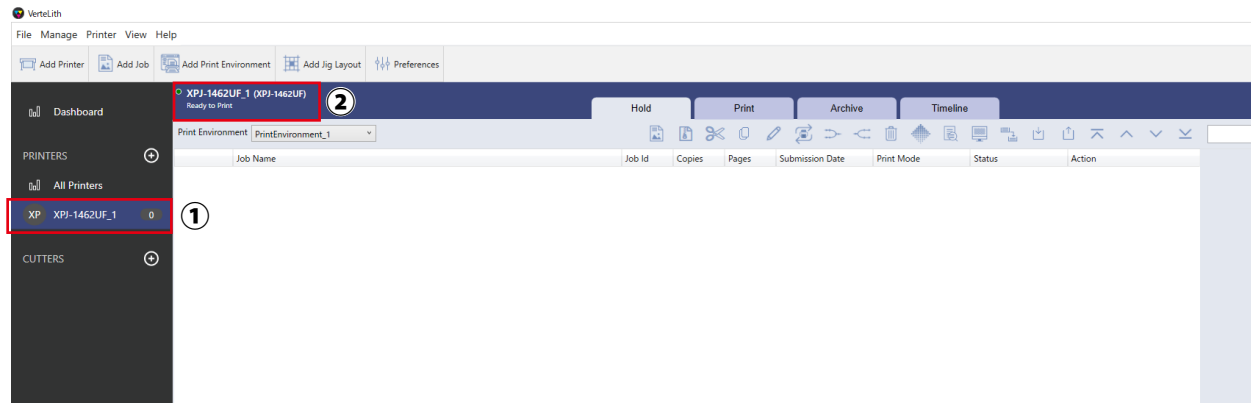

### Note

For how to add a printer to VerteLith, see the VerteLith user manual.

Before Use

Setup

Various Settings

Basic Operations

Advanced Operations

Maintenance

When problems occur

Appendix

Printing

Sleep Mode

Stop the printer for emergency

3

Add an image file you want to print.

- In the Hold queue, click the [Add Job] icon (3) so that the open dialog appears.

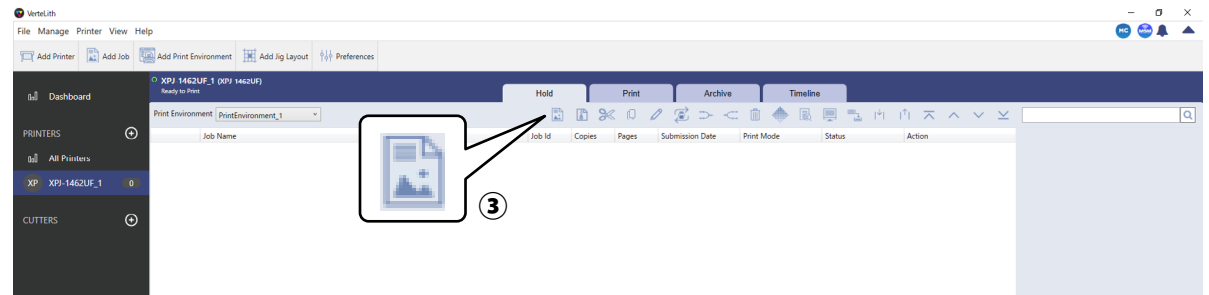

- Select an image file and click [OK] to add it to the Hold queue (4). You can add multiple files here.

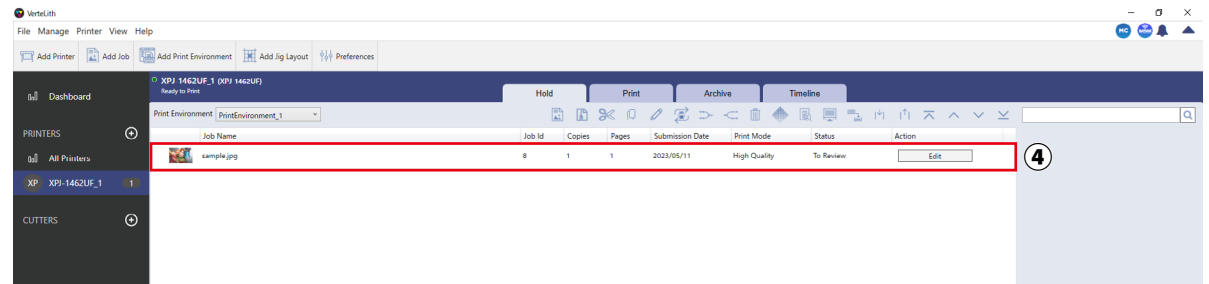

Note

- You can also drag and drop files in the Hold queue.

Before Use

Setup

Various Settings

Basic Operations

Advanced Operations

Maintenance

When problems occur

Appendix

Printing

Sleep Mode

Stop the printer for emergency

4

Select a print job and click [Edit] (⑤) or [Edit Job] (⑥) .

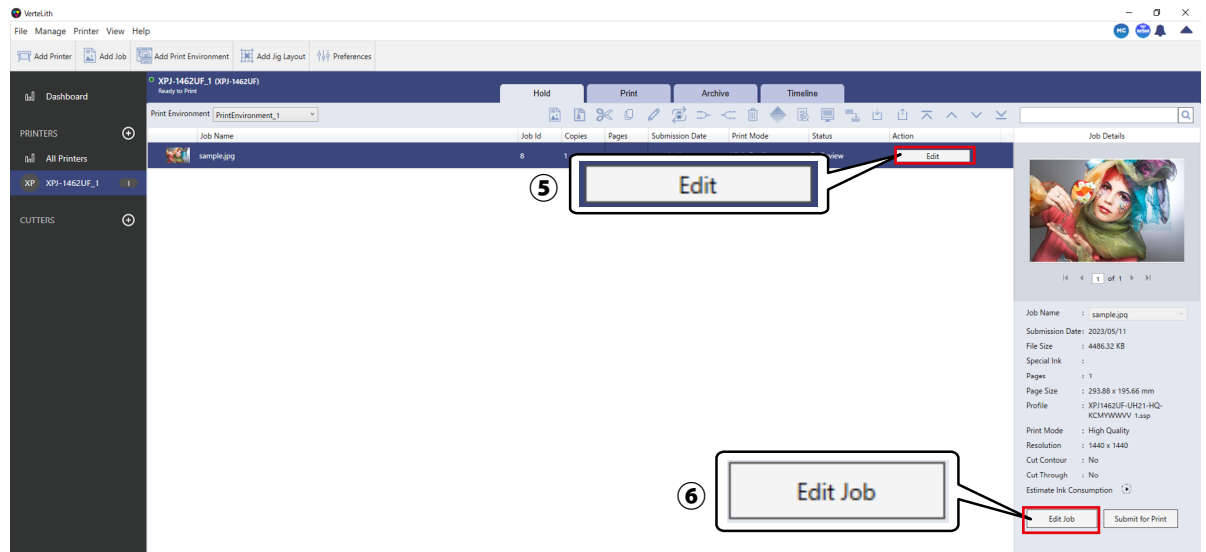

5

[Edit Job Settings] (⑦) appears. Click the Printer Profile tab (⑧) .

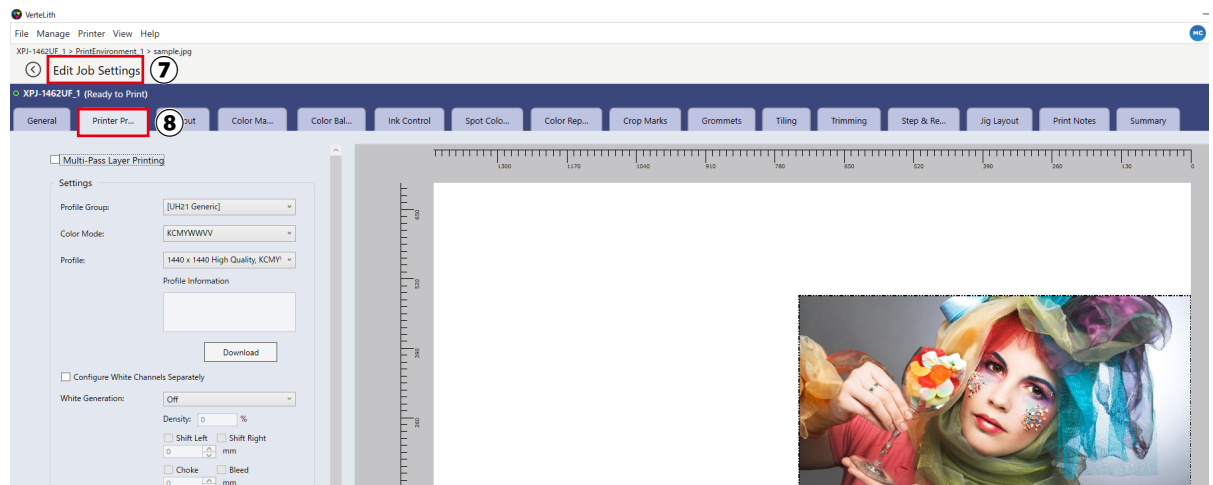

Before Use

Setup

Various Settings

Basic Operations

Advanced Operations

Maintenance

When problems occur

Appendix

Printing

Sleep Mode

Stop the printer for emergency

6

## Configure the basic print settings.

### Profile Group option (9)

- Select an appropriate profile group depending on the ink being used.

### Profile option (10)

- Select an appropriate profile depending on the media type and print mode.

### Printer Options (11)

- Additional advanced settings can be configured (you can also print with default settings).

#### Note

This example shows the settings for a single layer printing with color inks. Change the settings depending on the types of printing you want.

☞ ["Advanced Operations" P.150](#)

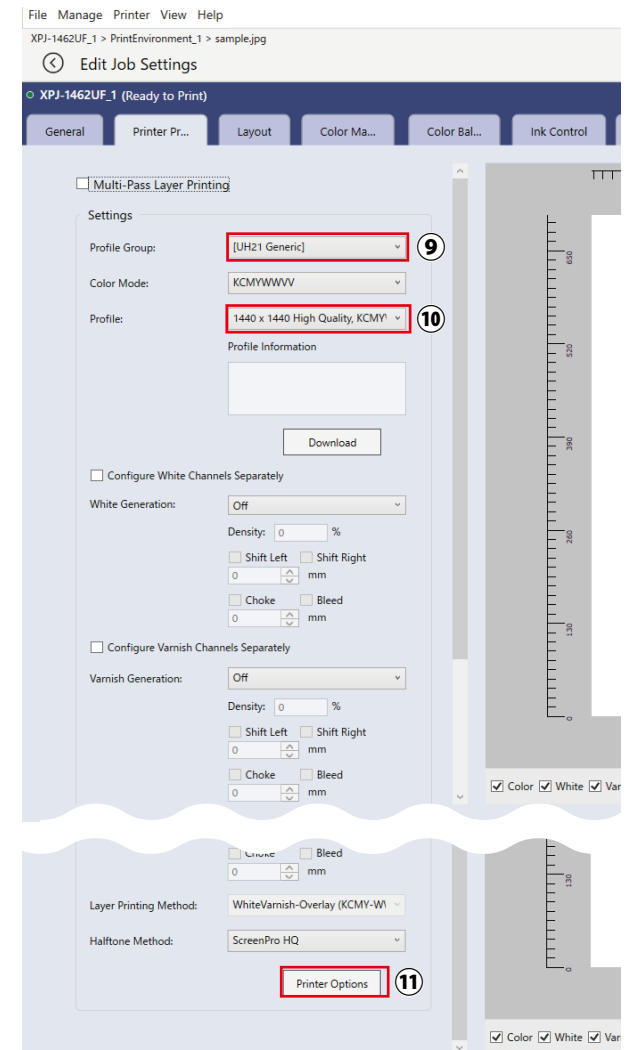

Before Use

Setup

Various Settings

Basic Operations

Advanced Operations

Maintenance

When problems occur

Appendix

Printing

Sleep Mode

Stop the printer for emergency

- 7 Once you have set the print settings, click [Submit for Print] (12) so that the job will move to the Print queue. Printing begins after RIP processing.

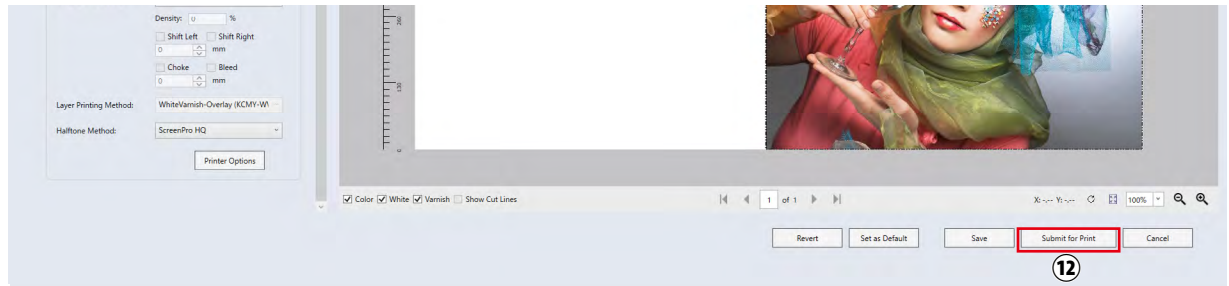

- The processing status of the job (Sending, Waiting for ripping, Ripping, Waiting for Print) can be viewed (13).

Job Id	Copies	Pages	Submission Date	Print Mode	Status	Progress	Cancel	Preview
11	1	1	2023/05/11	High Quality	Ripping (13)	<div style="width: 50%;"></div>	✕	

- The job will automatically move to the Hold queue after printing (14).

Job Name	Job Id	Copies	Pages	Submission Date	Print Mode	Status	Action
sample.jpg	8	1	1	2023/05/11	High Quality	To Review (14)	Edit

- 8 When you are done printing for the day, perform a maintenance.  
☞ "Daily maintenance at the end of work" P.193

Before Use

Setup

Various Settings

Basic Operations

Advanced Operations

Maintenance

When problems occur

Appendix

Printing

Sleep Mode

Stop the printer for emergency

## Pause / Resume / Cancel a print job

1

Clicking the [Pause Print] icon (①) will put the RIP processed job into “Waiting for Print” status (you cannot pause the job being sent).

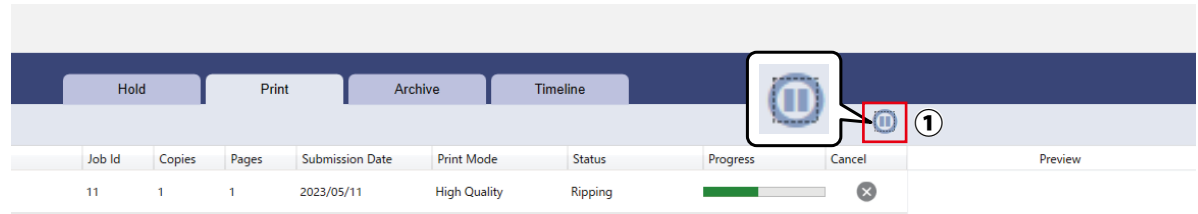

2

Clicking the [Resume Print] icon (②) will resume the print job which is in “Wait for Print” status.

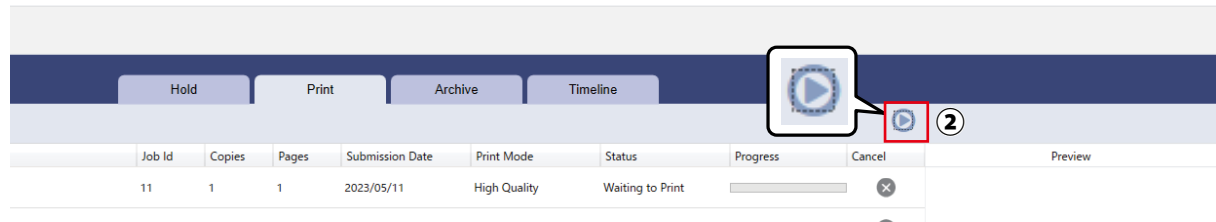

3

Clicking the [Cancel] icon (③) will cancel printing the job.

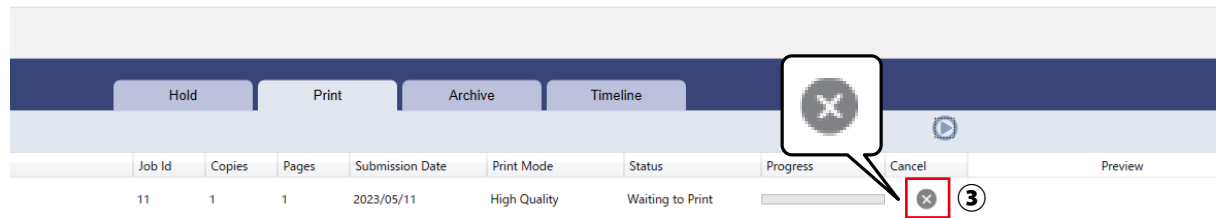

Before Use	
Setup	
Various Settings	
<b>Basic Operations</b>	<b>Printing</b>
Advanced Operations	Sleep Mode
Maintenance	Stop the printer for emergency
When problems occur	
Appendix	

## Pause / Resume printing

Perform this operation from the printer control panel.

- 1 Tap  Cancel key while printing.

  - The print job is paused.
  - The message [Pausing Print Cancel Print -> Enter] appears.

### Note

- This will not delete a print job sent to the printer.
- To cancel printing and delete a print job, refer to the following section.

 ["Cancel printing" P.143](#)

- 2 To resume printing, tap  Cancel key again.

### Important !

MUTOH cannot guarantee print quality of prints paused once.

Before Use

Setup

Various Settings

Basic Operations

Advanced Operations

Maintenance

When problems occur

Appendix

Printing

Sleep Mode

Stop the printer for emergency

## Cancel printing

Perform this operation from the printer control panel.

1

Tap  Cancel key while printing.

- The print job is paused.
- The message [Pausing Print Cancel Print -> Enter] appears.

### Note

Tapping  Cancel key again will resume printing.



2

Tap  Enter key so that the printing is canceled (you cannot resume printing).

- This will delete a print job sent to the printer.

### Important!

If the status light is blinking green after the gantry goes back to the home position, tap  Cancel key again and follow these steps to cancel printing.

- [Media Setting1 Cancel Print] appears.
- Tap  key. → When [Cancel Print Start → Enter] appears, tap  Enter key.
- The message [Canceling ] appears and a print job sent to the printer will be deleted.

If the status light is still blinking green, tap  key to put the printer in ready-to-print state and do steps 1 and 2 again.

### Note

You can also cancel printing from Mini MSM.

- Clicking the [Print Cancel] icon while printing will cancel the print job (you cannot resume printing).

 ["MiniMSM" P.96](#)

Before Use	
Setup	
Various Settings	
<b>Basic Operations</b>	<b>Printing</b>
Advanced Operations	Sleep Mode
Maintenance	Stop the printer for emergency
When problems occur	
Appendix	

## Displaying the time until the next time ink agitation is required

- 1 While "Print Ready" or "Set media, then Tap [ ^ ] key" appears, tap  [Enter] key.
- 2 The time until the next ink agitation is required is displayed.  
For details, see ["Agitating ink from the direct key" P.175](#)

Before Use

Setup

Various Settings

Basic Operations

Advanced Operations

Maintenance

When problems occur

Appendix

Printing

Sleep Mode

Stop the printer for emergency

# Sleep Mode

This product must be powered on all the time. While not in use, make sure to put it into sleep mode.

Failure to do so may result in ink settling, causing print defects or printer failure.

When waking from sleep mode, the printer will perform automatic maintenance depending on the elapsed time.

## Sleep mode flow

Before putting the printer into sleep mode, follow the instructions on the printer control panel to perform a daily maintenance. For detailed procedures, please refer to the following.

 ["Daily maintenance at the end of work" P.193](#)

Before Use

Setup

Various Settings

Basic Operations

Advanced Operations

Maintenance

When problems occur

Appendix

Printing

Sleep Mode

Stop the printer for emergency

## If you are going to leave the printer in sleep mode for a long period of time

If you are going to leave the printer in sleep mode for a long period of time, perform followings in advance.

- Check that the ink cartridges (ink bags) have sufficient ink.

 [“Check the ink level” P.181](#)

- Empty the waste ink tank.

 [“Empty the waste ink tank” P.189](#)

### Important !

During sleep mode, check the ink level in the ink cartridges (ink bags). When the message [Ink Low] appears on the control panel, replace with new ones.

 [“Checking ink level and replacing ink” P.181](#)

## To wake up from sleep mode

- 1 To wake up from sleep mode, tap  [Enter] key.

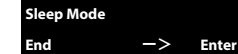

Sleep Mode  
End      ->      Enter

### Note

When the printer wakes up from sleep mode, an appropriate automatic cleaning (head cleaning or “Little Charge”) will be performed depending on the elapsed time.

Before Use

Setup

Various Settings

Basic Operations

Advanced Operations

Maintenance

When problems occur

Appendix

Printing

Sleep Mode

Stop the printer for emergency

# Stop the printer for emergency

This printer has four emergency stop buttons for safety.

## Location of emergency stop button

Two buttons are located on the front left and right of the printer and two buttons are located on both ends of the gantry.

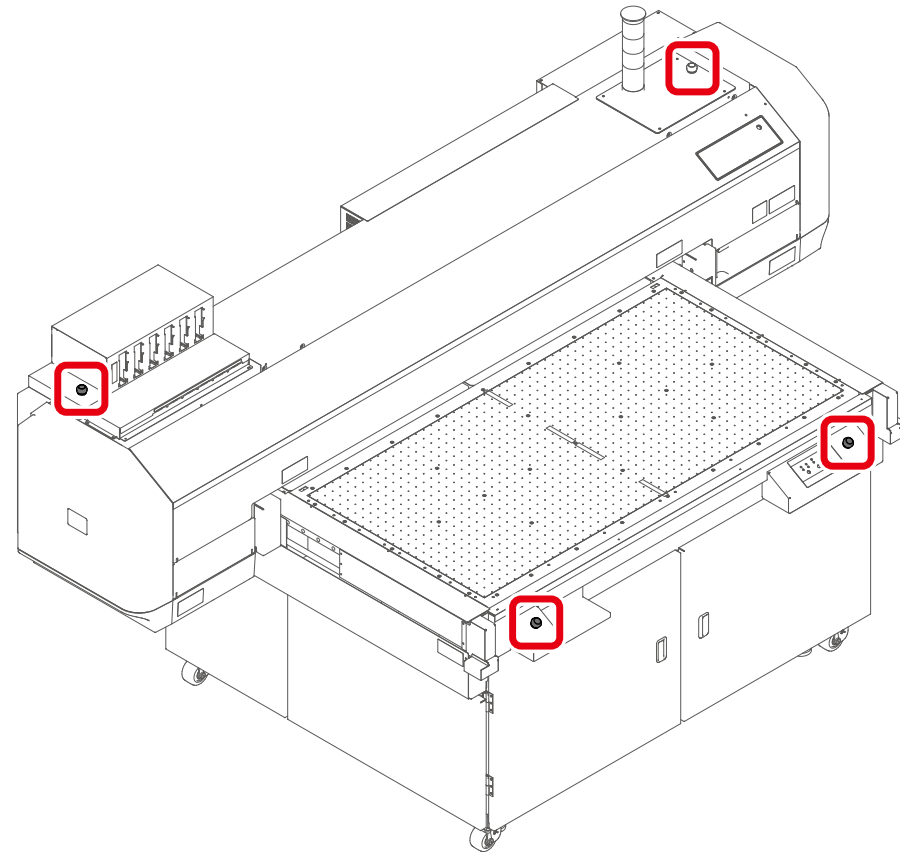

Before Use

Setup

Various Settings

Basic Operations

Advanced Operations

Maintenance

When problems occur

Appendix

Printing

Sleep Mode

Stop the printer for emergency

## Procedure

- 1 Press the emergency stop button.
  - The printer stops.

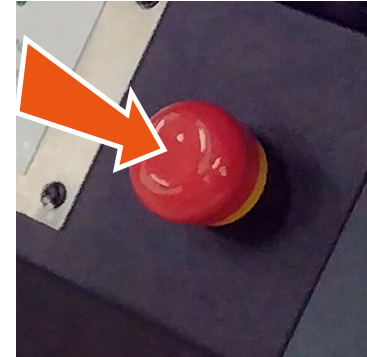

- 2 The message [Emergency Stop Reboot Printer] appears.
  - Press the Power button for more than two seconds.
  - The printer will restart and the startup message (including version number) will be displayed.

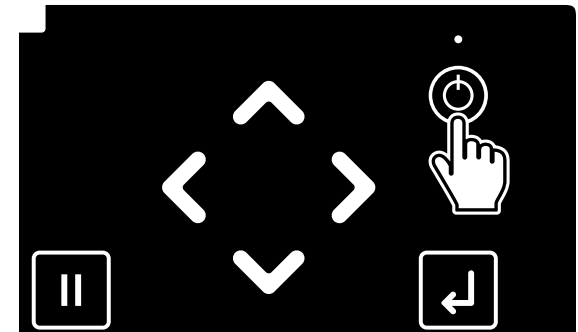

- 3 The message [Release emergency stop button] appears.
  - To release the emergency stop state, turn the button to the right.

### Note

This message is not displayed when the emergency stop button is already released.

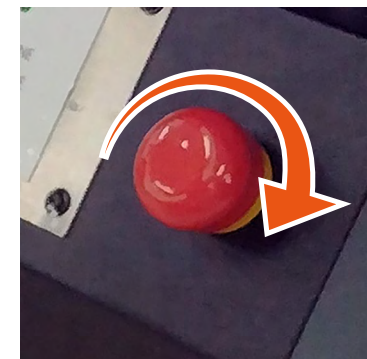

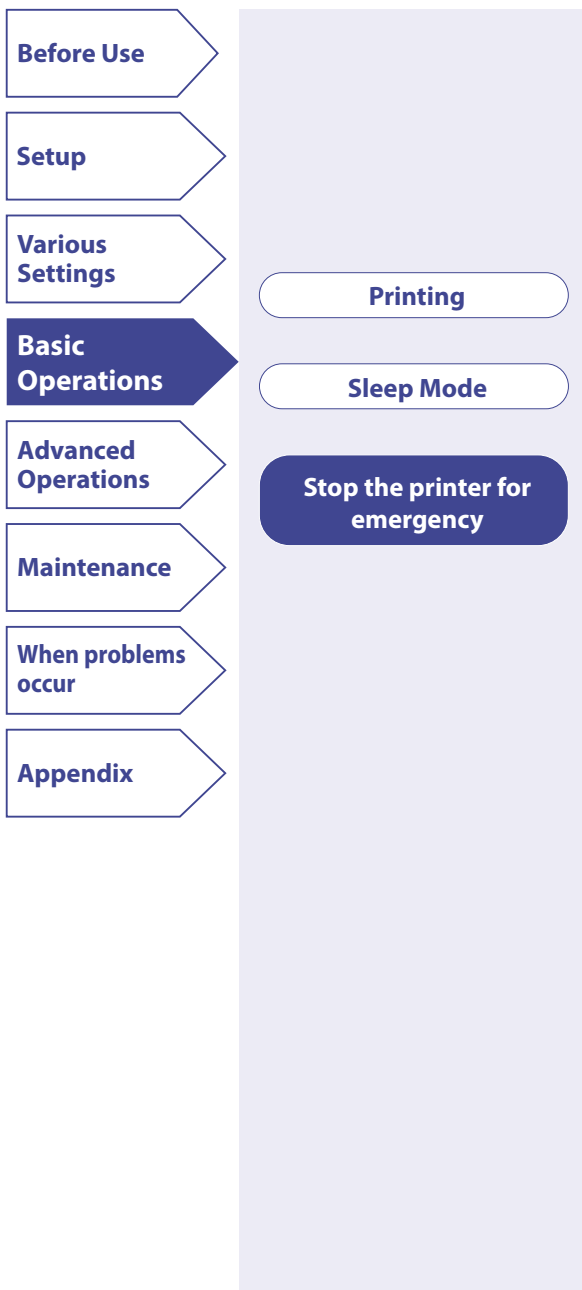



---

**4** The message [Releasing] appears.

- The gantry goes up.

---

**5** The message [Confirm safety? No] appears.

- Once safety has been confirmed, use  /  key to select [Confirm safety? Yes].
- Tap  Enter key.

---

**6** The message [Initializing] appears.

---

**7** The message [Set media. then Tap [ ^ ] key] appears.

- The printer is ready to print.

---

# Advanced Operations

Layer printing

151

Jig layout printing

160

Before Use

Setup

Various Settings

Basic Operations

Advanced Operations

Maintenance

When problems occur

Appendix

Layer printing

Jig layout printing

# Layer printing

## Single-pass layer printing

XPJ-1462UF is capable of printing two layers of white or varnish and color in a single pass. We call it "single-pass layer printing". The white or varnish layer can be automatically generated from a single image file to be printed over (overlay printing) or under (underlay printing) a color layer as shown below. Because of the print head structure of this product, the gantry moving direction is different between these printings.

### White or Varnish Overlay printing

White or varnish layer is printed over color layer while the gantry moves from front to back of the table.

#### Layer printing image

WH only  
or  
VA only  
or  
WH + VA



Color



Media



#### Gantry moving direction

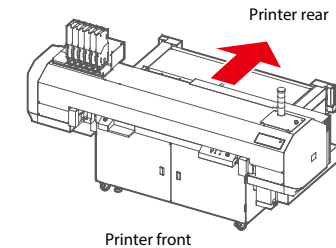

### White or Varnish Underlay printing

White or varnish layer is printed underneath color layer while the gantry moves from back to front of the table.

#### Layer printing image

Color



WH only  
or  
VA only  
or  
WH + VA



Media



#### Gantry moving direction

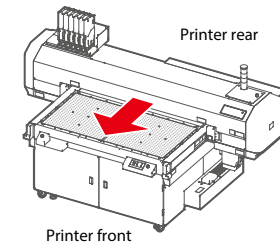

Before Use

Setup

Various Settings

Basic Operations

Advanced Operations

Maintenance

When problems occur

Appendix

Layer printing

Jig layout printing

## Settings for single-pass layer printing

In the Edit Job Settings, click the Printer Profile tab and set the following options:

### Color Mode (①)

- Select [KCMYWWVV].
- With this color mode, you can generate white (or varnish) layer from an image file (color data).

### White Generation (②)

- Select a white layer generation method from the drop-down list and specify density, position correction, and edge correction as needed.

### Varnish Generation (③)

- Select a varnish layer generation method from the drop-down list and specify density, position correction, and edge correction as needed.

### Layer Printing Method (④)

- To print white or varnish layer over color layer, select [WhiteVarnish-Overlay]. To print color layer over white or varnish layer, select [WhiteVarnish-Underlay].

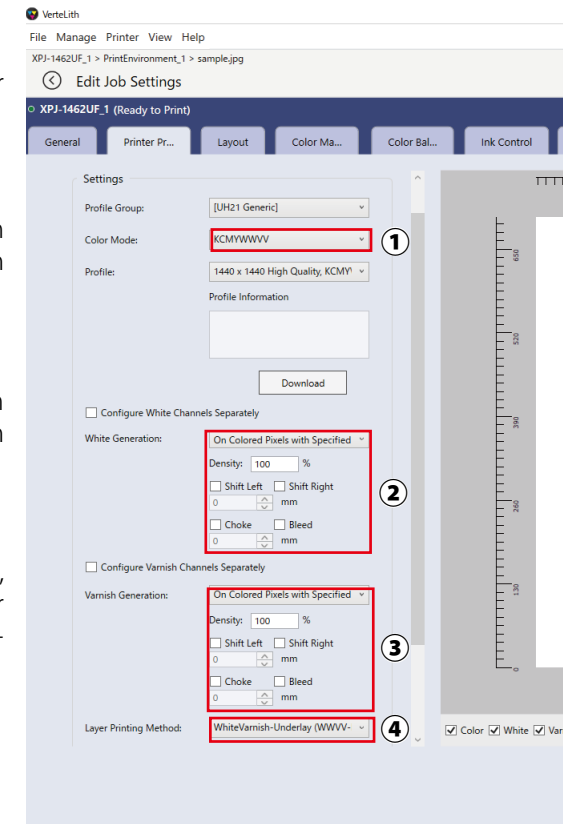

Before Use

Setup

Various Settings

Basic Operations

Advanced Operations

Maintenance

When problems occur

Appendix

Layer printing

Jig layout printing

## Multi-pass layer printing

Multi-pass layer printing is another layer printing method, allowing you to print multiple layers one by one on the same area. Each layer is printed according to the color mode you will specify. Use this method when you want to print more than three layers using a single image file like below example.

- Example of White printing + Single-pass layer printing

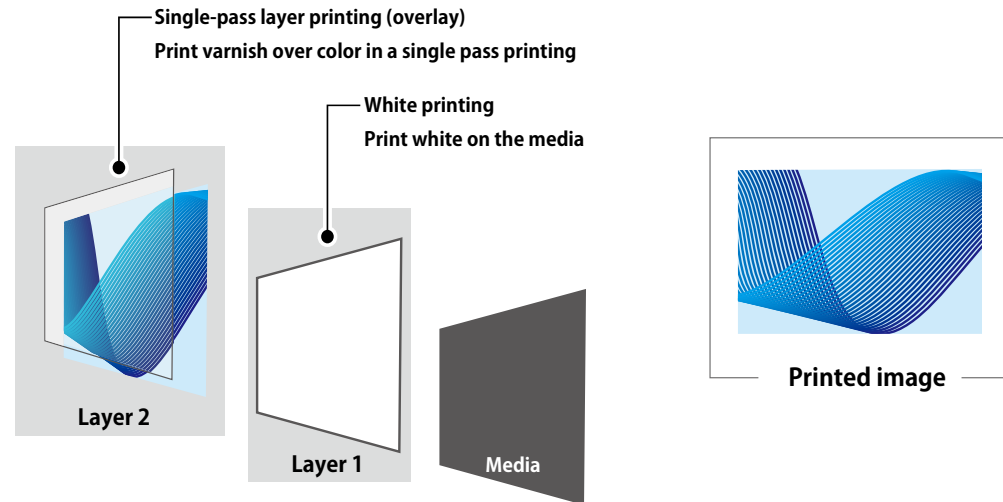

## Settings for multi-pass layer printing

- 1 In the Edit Job Settings, click the Printer Profile tab and select the [Multi-Pass Layer Printing] checkbox (①).
  - The layer list view appears (②).

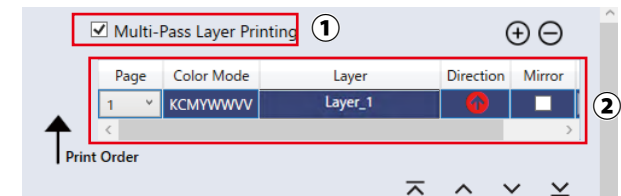

Before Use

Setup

Various Settings

Basic Operations

Advanced Operations

Maintenance

When problems occur

Appendix

Layer printing

Jig layout printing

2 Click the [+] icon (3) to add a layer.

- [Layer\_2] is added above [Layer\_1] (4).
- Each layer is printed on the media from the bottom of the list.

Note

Clicking the [+] icon while selecting a layer will copy the selected layer and clicking the [-] icon will delete the selected layer.

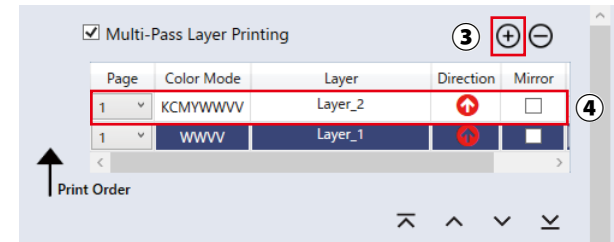

Important!

List view structure for multi-pass layer printing

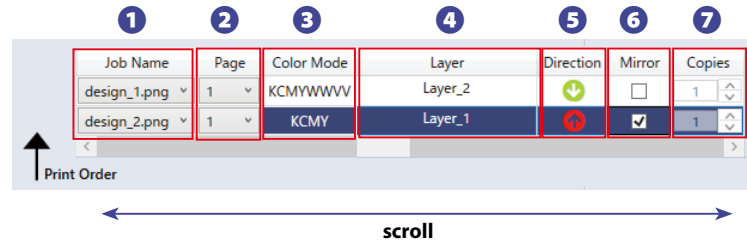

- 1 Job Name Displays the name of nested job. (only displays when job is nested)  
["Multi-pass layer printing with nesting" P.156](#)
- 2 Page Select the page number to be printed when printing multiple-page PDF file.
- 3 Color Mode Displays the selected color mode.
- 4 Layer Indicates the printing order.
- 5 Direction Displays the gantry moving direction while printing. ⬇️ means the gantry moves back to front. ⬆️ means the gantry moves from front to back.
- 6 Mirror Selecting the checkbox will flip an image.
- 7 Copies Change the number of copies to be created in the same layer.

Before Use

Setup

Various Settings

Basic Operations

Advanced Operations

Maintenance

When problems occur

Appendix

Layer printing

Jig layout printing

- 3** Select the layer from the list view and specify the print settings.  
In this example, we will change [Layer\_1] to a white layer data and generate a varnish layer data from [Layer\_2] to print varnish layer over color layer (overlay printing).

Click to select [Layer\_1] ( ⑤ ) and specify as follows:

- Color Mode: [WWV]
- White Generation: [On All Pixels with Specified Density]
- Density: [100%]
- Varnish Generation: [Off]
- Printing Direction: [Forward]

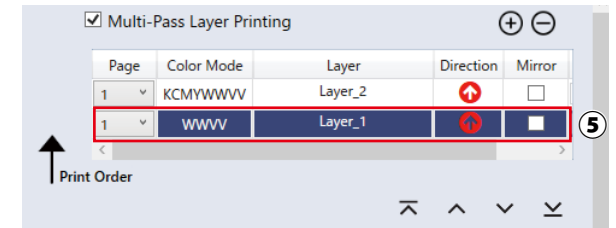

Click to select [Layer\_2] ( ⑥ ) and specify as follows:

- Color Mode: [KCMYWWV]
- White Generation: [Off]
- Varnish Generation: [On All Pixels with Specified Density]
- Density: [100%]
- Layer Printing Method: [WhiteVarnish-Overlay (KCMY-WWV)]

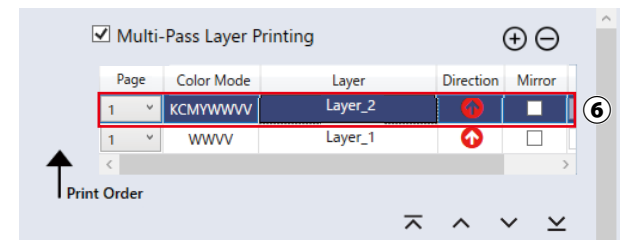

- 4** Once you have set the print settings, click [Submit for Print] on the bottom right so that the job will move to the Print queue. Printing begins after RIP processing.

Before Use

Setup

Various Settings

Basic Operations

Advanced Operations

Maintenance

When problems occur

Appendix

Layer printing

Jig layout printing

## Multi-pass layer printing with nesting

To perform multi-pass layer printing using multiple image files, the "nesting" function helps you to get your printing done efficiently. In this example, we will explain how to nest two image files and configure multi-pass layer printing to be able to view different images on the front and back as the illustration below.

- Example of Color printing + Single-pass layer printing

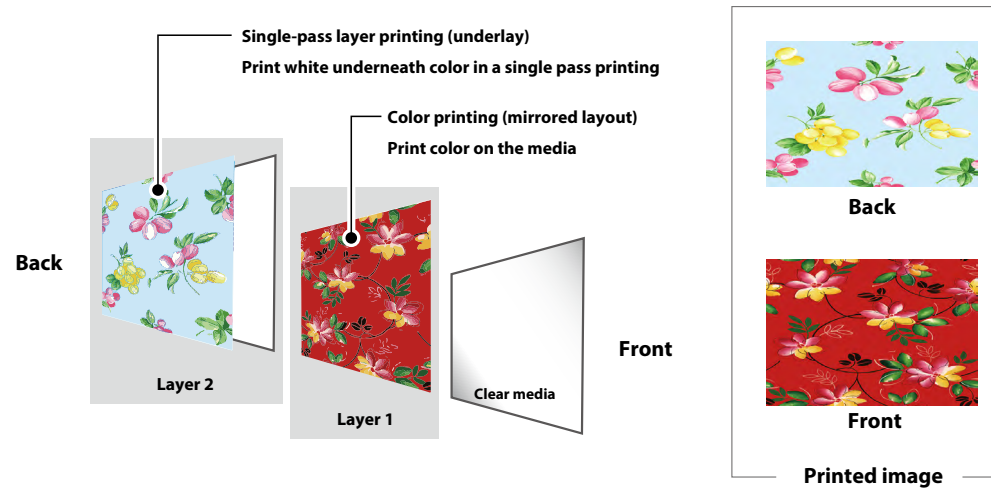

## Nesting procedure and print settings

1

Click to select the print jobs you want to nest. (1)

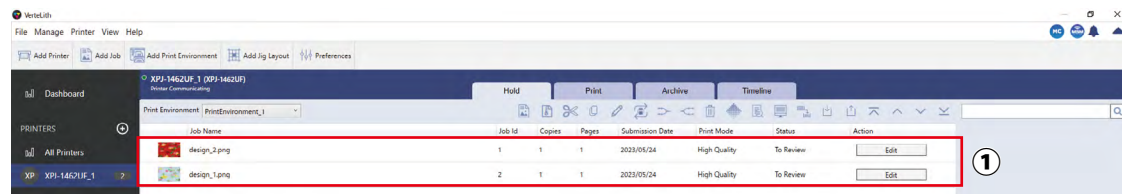

Before Use

Setup

Various Settings

Basic Operations

Advanced Operations

Maintenance

When problems occur

Appendix

Layer printing

Jig layout printing

2

Click the [Nest] icon. ( ② )

- Once nested, the display will change like below. ( ③ )

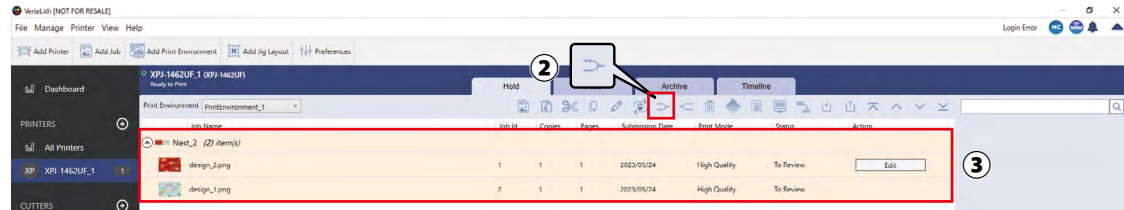

### Note

- You can also nest the print jobs from the right-click menu.
- VerteLith also offers the auto nesting function to be able to automatically nest all the jobs newly added to VerteLith. For details, see the VerteLith user manual.

3

Click to select the nested job and click [Edit] or [Edit Job].

4

In the Edit Job Settings, click the Printer Profile tab and select the [Multi-Pass Layer Printing] checkbox. ( ④ )

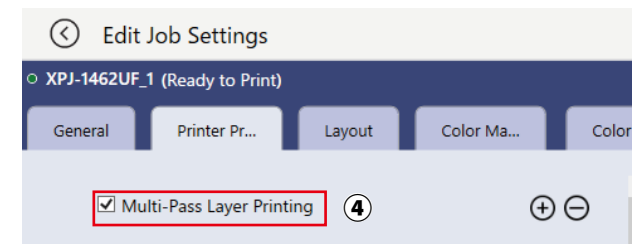

Before Use

Setup

Various Settings

Basic Operations

Advanced Operations

Maintenance

When problems occur

Appendix

Layer printing

Jig layout printing

- 5 The [Nested Jobs Arrangement] option appears.
- Select [Layer] (5) .

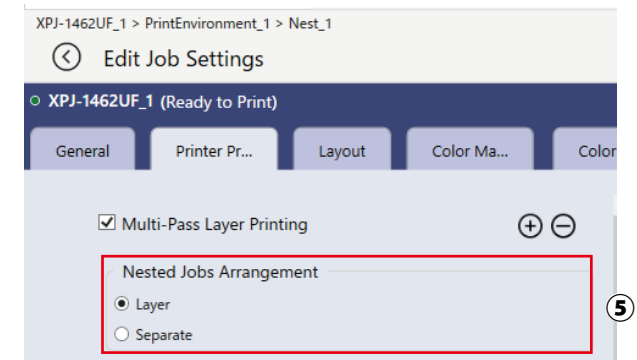

- 6 The list view of the print job assigned to each layer appears. (6)

- Each layer is printed on the media from the bottom of the list.
- Bring the job you want to directly print on the media (bottom layer) to the bottom of the list. In this example, the job assigned to [Layer\_2] is the bottom layer and the job assigned to [Layer\_1] is printed over [Layer\_2].

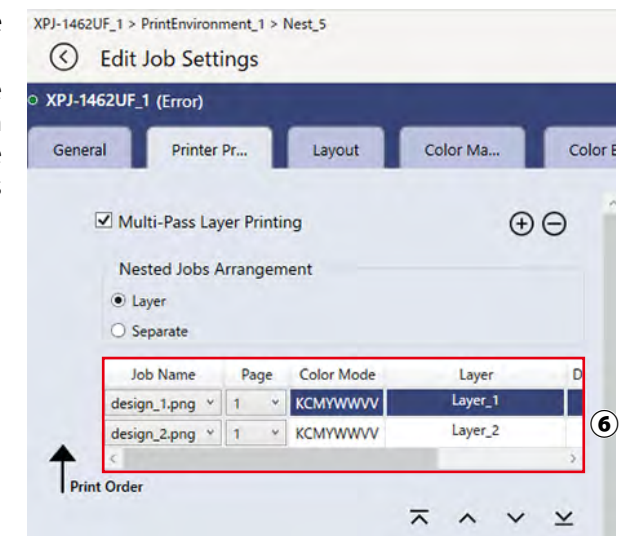

**Note**

Use icon to change the printing order.

bring to top layer      bring to bottom layer

move up      move down

Before Use

Setup

Various Settings

Basic Operations

Advanced Operations

Maintenance

When problems occur

Appendix

Layer printing

Jig layout printing

7

Select the layer from the list view and specify the print settings for each layer.  
In this example, we will flip the image in [Layer\_1] (to view from the back of the clear media) and generate a white layer data from [Layer\_2] to print white layer under color layer (underlay printing).

Click to select [Layer\_1] ( ⑦ ) and specify as follows:

- Select the [Mirror] checkbox. (⑧)
- Color Mode: [KCMY]
- Printing Direction: [Forward]

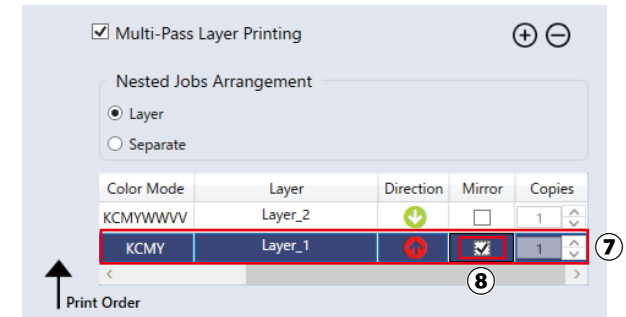

Click to select [Layer\_2] ( ⑨ ) and specify as follows:

- Color Mode: [KCMYWWWV]
- White Generation: [On All Pixels with Specified Density]
- Density: [100%]
- Layer Printing Method: [WhiteVarnish-Underlay (KCMY-WWWW)]

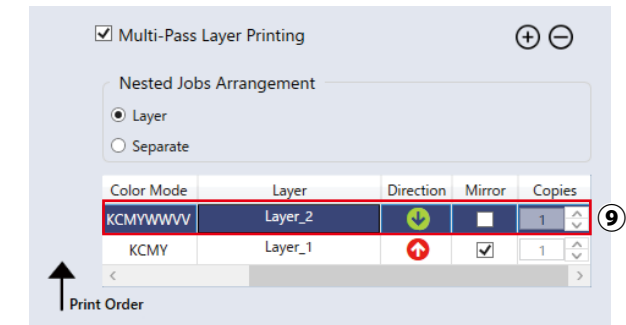

Before Use

Setup

Various Settings

Basic Operations

Advanced Operations

Maintenance

When problems occur

Appendix

Layer printing

Jig layout printing

# Jig layout printing

The Jig Layout function creates and saves a layout template with the specified position and the number of jig slots to arrange your design. It allows you to print on multiple objects placing on the table with equal space at once. You can also print the created jig layout to use it as simple jig.

Example of jig layout settings using nested jobs

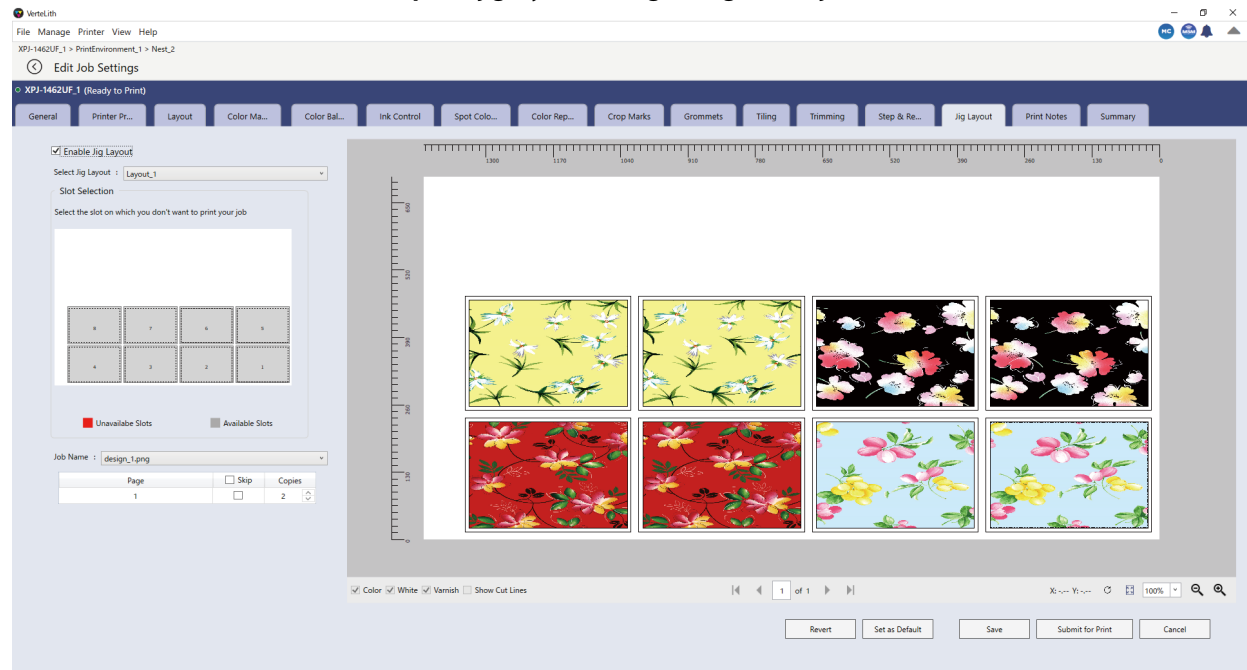

Before Use

Setup

Various Settings

Basic Operations

Advanced Operations

Maintenance

When problems occur

Appendix

Layer printing

Jig layout printing

## Printing procedure using jig layout

You will first create a jig layout.

### Create a jig layout

1

Click [Add Jig Layout]. ( ① )

- The Add New Jig Layout dialog appears.

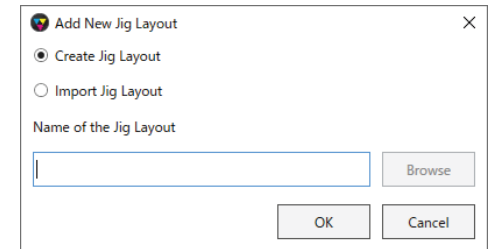
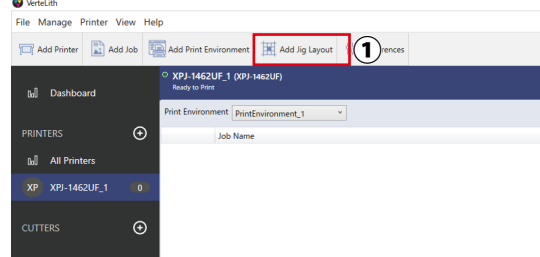

2

Select [Create Jig Layout] ( ② ), enter a name of the jig layout and then click [OK] ( ③ ).

#### Important!

By selecting [Import Jig Layout], you can import a jig layout created by the external application.

[Procedure]

- Select [Import Jig Layout].
- Click [Browse] and select a jig layout file saved in SVG format.
- Click [OK]. The Add Jig Layout page will appear.

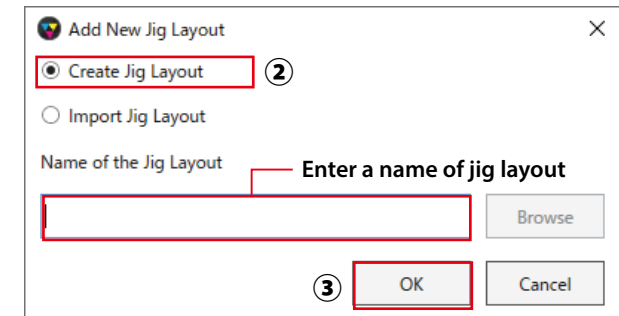

Before Use

Setup

Various Settings

Basic Operations

Advanced Operations

Maintenance

When problems occur

Appendix

Layer printing

Jig layout printing

3

In the Add Jig Layout, specify the following settings:

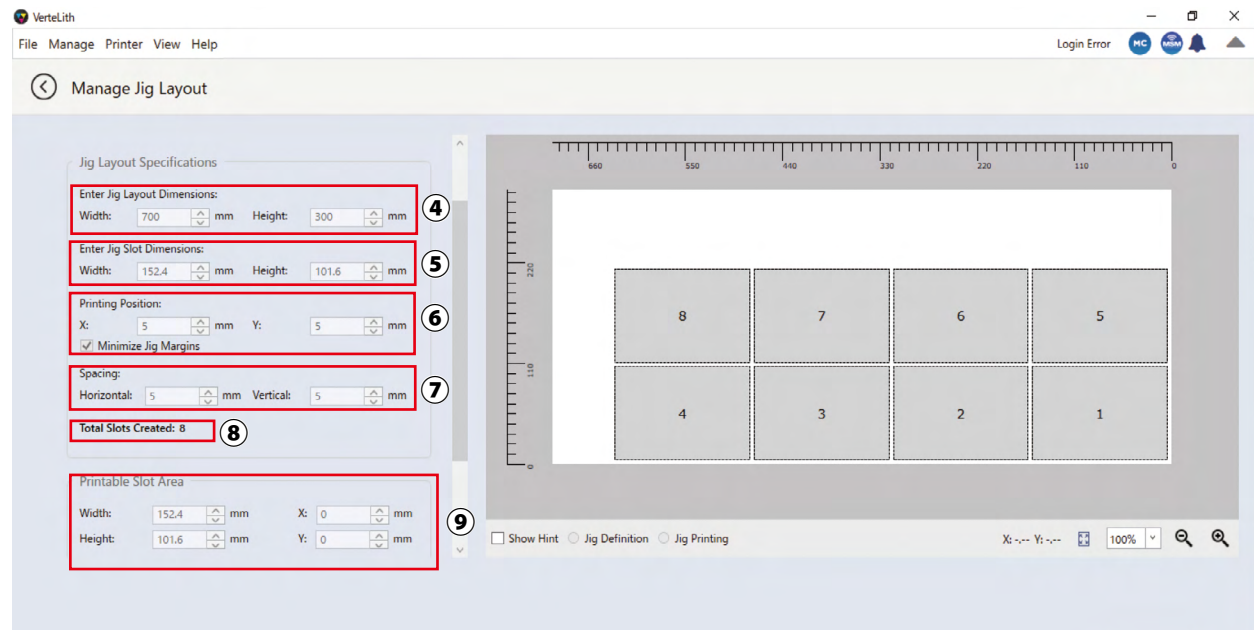

#### Enter [Jig Layout Dimensions] (4)

- Enter width and height of a jig.

#### Enter [Jig Slot Dimensions] (5)

- Jig slot is the frame that a print job is arranged. Enter the same width and height as the job file.

#### Printing Position (6)

- Specify the X/Y value of the bottom right that the jig slot is placed.
- When the [Minimize Jig Margins] checkbox is selected, you can set the minimum X/Y values to 0 mm. When disabled, the minimum X/Y value will be 5 mm.

#### Spacing (7)

- Specify the space between jig slots in the horizontal and vertical direction.

Before Use

Setup

Various Settings

Basic Operations

Advanced Operations

Maintenance

When problems occur

Appendix

Layer printing

Jig layout printing

### Total Slots Created (⑧)

- The number of jig slots is displayed. In this example, 8 jig slots have been created.

### Printable Slot Area (⑨)

- Specify width and height of the print area of the job.

### Note

By selecting the [Show Hint] checkbox (⑩), you can see the explanation of Jig Definition and Jig Printing.

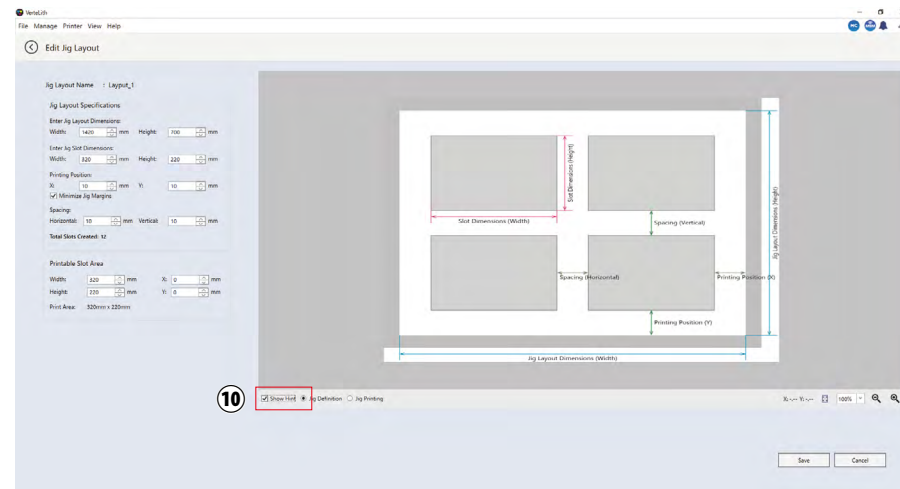

Before Use

Setup

Various Settings

Basic Operations

Advanced Operations

Maintenance

When problems occur

Appendix

Layer printing

Jig layout printing

## Print a job using jig layout

You will lay out a print job in the created jig layout and print it.

1

Select a print job you want to print and click [Edit] (①). In this example, we will select the nested job.

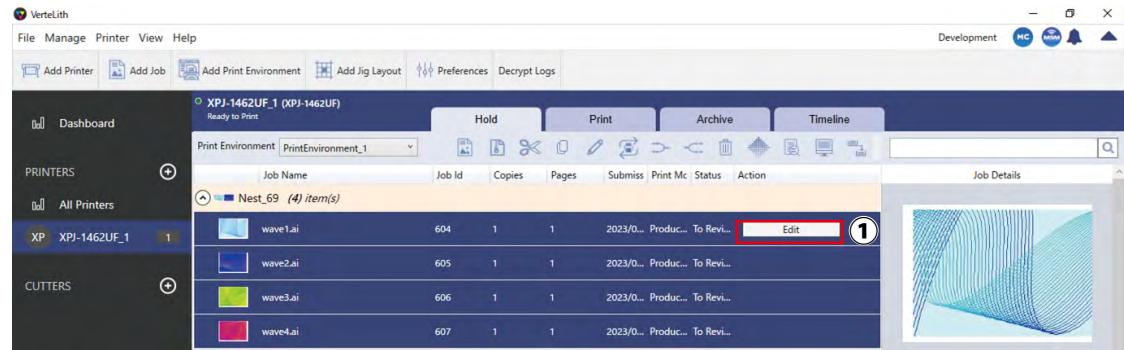

2

In the Edit Job Settings, click the Jig Layout tab (②)

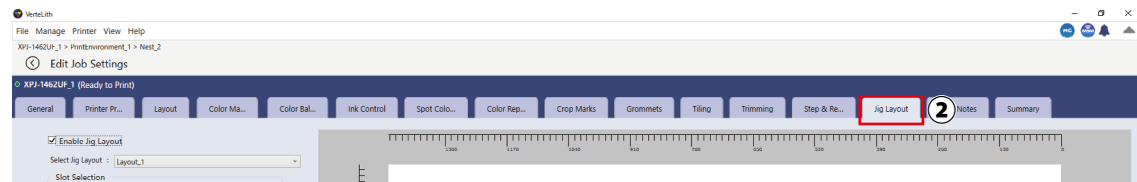

3

Select the [Enable Jig Control] checkbox (③).

- From the Select Jig Layout drop-down list, select the jig layout you created (④).

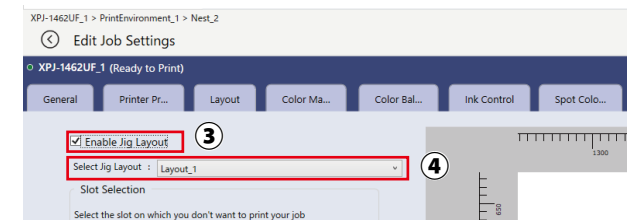

Before Use

Setup

Various Settings

Basic Operations

Advanced Operations

Maintenance

When problems occur

Appendix

Layer printing

Jig layout printing

4

The selected jobs are arranged in the jig layout slot automatically (5). Specify the following settings as needed.

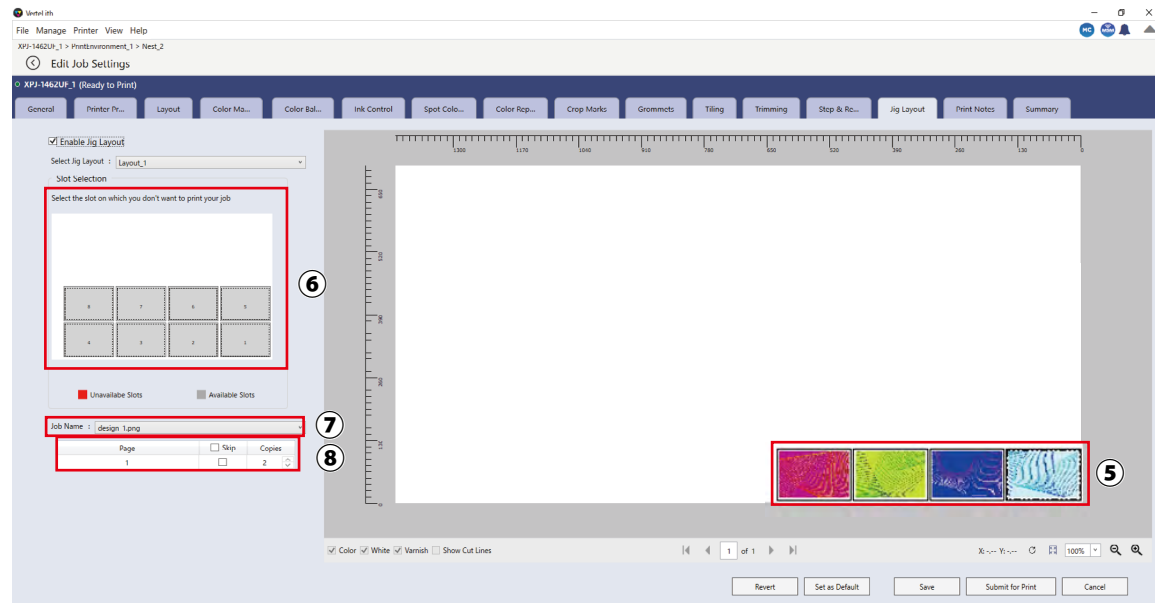

#### Select slot (6)

Select the slot you will not print.

#### Job name (7)

When the nested job is selected, select a job you want to arrange.

#### Page layout and copy (8)

- Specify the number of copies of the job and the page you will skip. If the number of copies is more than the number of jig slots, the remaining pages or copies will be printed in the next jig.

5

Once you have set the print settings, click [Submit for Print] on the bottom right so that the job will move to the Print queue. Printing begins after RIP processing.

Before Use

Setup

Various Settings

Basic Operations

Advanced Operations

Maintenance

When problems occur

Appendix

Layer printing

Jig layout printing

## Simple jig

You can print a jig layout you created and use it as a simple jig.

1 Select [Manage] > [Jig Layout] (①).

- The Manage Jig Layout page appears.

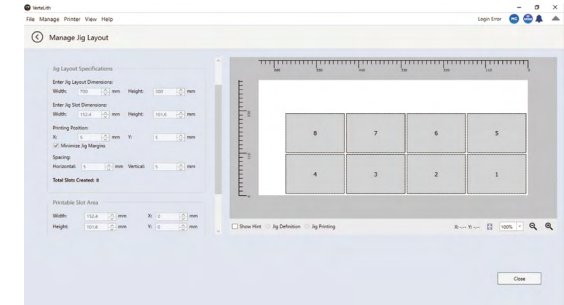
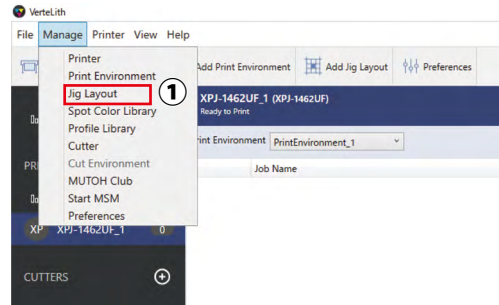

2 Select the [Enable Jig Layout Printing] checkbox (②).

- The Print Jig Layout option appears (③).

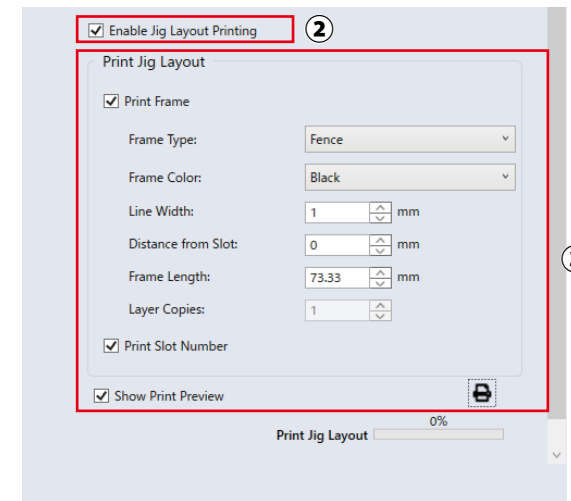

Before Use

Setup

Various Settings

Basic Operations

Advanced Operations

Maintenance

When problems occur

Appendix

Layer printing

Jig layout printing

3

Specify the following options as needed.

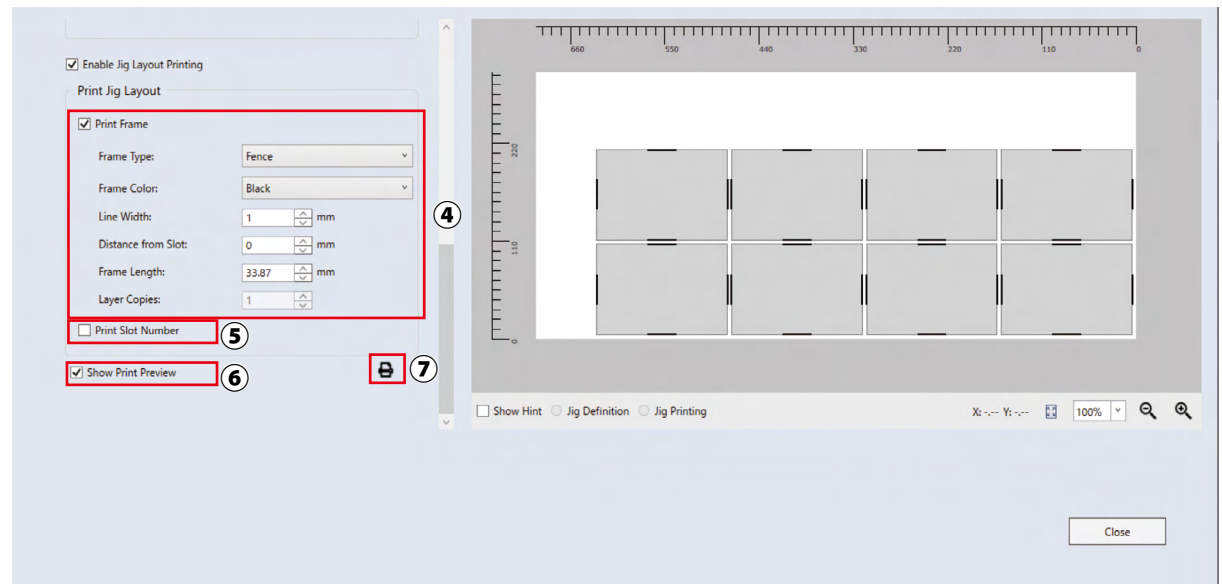

#### Print Frame (④)

- Print each slot with a frame. Select Frame Type and Frame Color from the drop-down list. Then specify Line Width, Distance from Slot, Frame Length and Layer Copies. In Layer Copies, you can specify the number of times the printer prints the layer.

#### Print Slot Number (⑤)

- Print each slot with a slot number.

#### Show Print Preview (⑥)

- When enabled, you can see the frame and the number added to the slot in preview.

#### Print Jig Layout icon (⑦)

- Click to display the Print Jig Layout dialog.

Before Use

Setup

Various Settings

Basic Operations

Advanced Operations

Maintenance

When problems occur

Appendix

Layer printing

Jig layout printing

4

Clicking the Print Jig Layout icon (7) will display the Print Jig Layout dialog.

- Select the print environment for the jig layout from the drop-down list (8).

**Note**

By clicking the Trial Jig Printing icon, you can test print one slot (9).

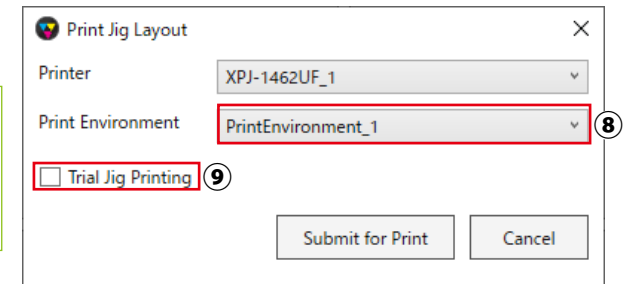

5

Click [Submit for Print] (10).

- Once the job has been sent to the printer, the printing progress will be display under the Print Jig Layout icon.

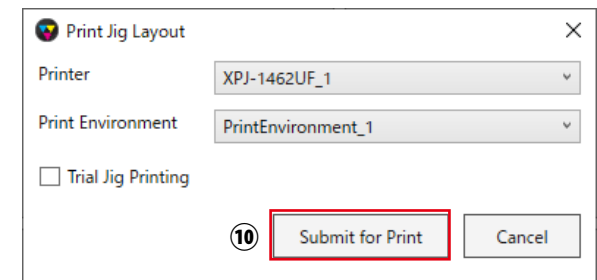

# Maintenance

<b>About Maintenance</b>	<b>170</b>
<b>Wearing protective equipment</b>	<b>171</b>
<b>Agitating ink</b>	<b>172</b>
<b>Checking ink level and replacing ink</b>	<b>181</b>
<b>Empty the waste ink tank</b>	<b>189</b>
<b>Daily maintenance at the end of work</b>	<b>193</b>
<b>Printer maintenance</b>	<b>204</b>
<b>Replacing consumable parts</b>	<b>218</b>
<b>When not using the printer for a long period of time</b>	<b>236</b>
<b>Moving or transporting printer</b>	<b>240</b>

Before Use

Setup

Various Settings

Basic Operations

Advanced Operations

Maintenance

When problems occur

Appendix

About Maintenance

Wearing protective equipment

Agitating ink

Checking ink level and replacing ink

Empty the waste ink tank

Daily maintenance at the end of work

Printer maintenance

















Replacing consumable parts

When not using the printer for a long period of time

Moving or transporting printer

# About Maintenance

To maintain your printer performance, please conduct the following maintenance.

When to perform maintenance	
Before daily printer operation	 <a href="#">"Wearing protective equipment" P.171</a>
	 <a href="#">"Agitating ink" P.172</a>
	 <a href="#">"Run a nozzle check and cleaning" P.78</a>
After daily printer operation	 <a href="#">"Daily maintenance at the end of work" P.193</a>
	 <a href="#">"Head cleaning" P.204</a>
When needed	 <a href="#">"Checking ink level and replacing ink" P.181</a>
	 <a href="#">"Replace the adapter's plug for high-capacity ink pack adapter" P.188</a>
	 <a href="#">"Empty the waste ink tank" P.189</a>
	 <a href="#">"Soak Cleaning" P.206</a>
	 <a href="#">"Cleaning each part of the printer" P.209</a>
	 <a href="#">"Maintenance for optional ionizer" P.211</a>
	 <a href="#">"Replace the flushing box pad" P.220</a>
	 <a href="#">"Replace the emitting window glass of the UV-LED lamp" P.227</a>
	 <a href="#">"Replace the filter of UV-LED lamp" P.230</a>
	 <a href="#">"Replacing and cleaning the exhaust fan filter" P.232</a>
Once in six months	 <a href="#">"Replace the cleaning wiper" P.224</a>

## Important!

In following cases, please contact your local MUTOH dealer to request service personnel.

- The same system error occurred repeatedly.
- The message notifying the life of motors, pumps or UV-LED lamp is displayed on the control panel.

 ["Messages and Error Messages" P.242](#)

Before Use

Setup

Various Settings

Basic Operations

Advanced Operations

Maintenance

When problems occur

Appendix

About Maintenance

Wearing protective equipment

Agitating ink

Checking ink level and replacing ink

Empty the waste ink tank

Daily maintenance at the end of work

Printer maintenance

Replacing consumable parts

When not using the printer for a long period of time

Moving or transporting printer

# Wearing protective equipment



**Make sure to read the following sections before this task.**

☞ "Handling" P.13

☞ "Ink and waste fluid" P.15

For the following tasks, make sure to wear protective equipment such as supplied gloves (or solvent-resistant gloves) and goggles.

- "Agitating ink" P.172
- "Checking ink level and replacing ink" P.181
- "Replace the adapter's plug for high-capacity ink pack adapter" P.188
- "Empty the waste ink tank" P.189
- "Daily maintenance at the end of work" P.193
- "Soak Cleaning" P.206
- "Cleaning each part of the printer" P.209
- "Maintenance for optional ionizer" P.211
- "Replace the flushing box pad" P.220
- "Replace the cleaning wiper" P.224
- "Replace the emitting window glass of the UV-LED lamp" P.227
- "Replace the filter of UV-LED lamp" P.230
- "Replacing and cleaning the exhaust fan filter" P.232

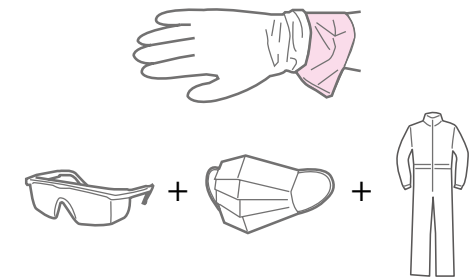

## How to wear the supplied gloves

Wear the rubber gloves over the polyethylene gloves.



Before Use

Setup

Various Settings

Basic Operations

Advanced Operations

Maintenance

When problems occur

Appendix

About Maintenance

Wearing protective equipment

Agitating ink

Checking ink level and replacing ink

Empty the waste ink tank

Daily maintenance at the end of work

Printer maintenance

Replacing consumable parts

When not using the printer for a long period of time

Moving or transporting printer

# Agitating ink

To avoid ink settling, you must agitate the ink in the ink bags in the following timing:

- Before loading a new ink bag
- When the following message appears on the control panel

Agitate W Ink

Agitate White (Wh)inks.

- This message appears every 12 hours.

Agitate KMCY Ink

Agitate Black (K), Magenta (M), Cyan (C) and Yellow (Y) inks.

- This message appears every 72 hours.

Agitate KMCYW Ink

Agitate Black (K), Magenta (M), Cyan (C), Yellow (Y) and White (Wh) inks.

- This message appears every 72 hours.

## Important!

- You must agitate ink in the ink bags regularly. Failure to do so could cause ink settling, leading to print defects or printer failure.
- The agitate ink message for CMYK inks may sometimes appear at the same timing as the one for white ink.
- You should agitate the ink when the message appears. Otherwise, for 12 hours after the message appears, you will repeatedly have to wait a certain time before you can print. When 12 hours have passed, the printer will not print any data. In either case, you can bring the printer back to normal condition by agitating the ink.



**Make sure to read the following sections before this task.**

👉 ["Handling" P.13](#)

👉 ["Ink and waste fluid" P.15](#)

Before Use	
Setup	About Maintenance
Various Settings	Wearing protective equipment
Basic Operations	<b>Agitating ink</b>
Advanced Operations	Checking ink level and replacing ink
<b>Maintenance</b>	Empty the waste ink tank
When problems occur	Daily maintenance at the end of work
	Printer maintenance
Appendix	Replacing consumable parts
	When not using the printer for a long period of time
	Moving or transporting printer

## Ink agitation procedure

You can agitate ink at your convenient timing even before the “Agitate Ink” message is prompted.

- If you want to print overnight or continuously, you can agitate ink beforehand to allow for a smooth and consistent printing.

There are two methods as follows:

- [“Agitating ink from “Menu 6 Ink Agitation”” P.173](#)
- [“Agitating ink from the direct key” P.175](#)

### Note

- [“You can also check the time until the next ink agitation from the Ink Agitation menu.” P.177](#)

### Agitating ink from “ Menu 6 Ink Agitation ”

- 1 Tap [Home] key so that [Menu1 Setup] appears. Use / / key to choose [Menu6 Ink agitation].

Menu 6  
Ink agitation

- 2 Tap key. The message [Ink agitation 1: Perform] appears.

Ink agitation 1  
Perform



- 3 Tap key so that [target ink: KMCYW] appears.

Target ink :

K M C Y W

Before Use	
Setup	About Maintenance
Various Settings	Wearing protective equipment
Basic Operations	<b>Agitating ink</b>
Advanced Operations	Checking ink level and replacing ink
<b>Maintenance</b>	Empty the waste ink tank
When problems occur	Daily maintenance at the end of work
Appendix	Printer maintenance
	Replacing consumable parts
	When not using the printer for a long period of time
	Moving or transporting printer

4

Use  /  key to select an ink color you want to agitate.  
 KMCYW: Select this when you want to agitate Black (K), Magenta (M), Cyan (C), Yellow (Y), White (Wh) inks.  
 KMCY: Select this when you want to agitate Black (K), Magenta (M), Cyan (C), Yellow (Y) inks.  
 W: Select this when you want to agitate White (Wh) ink.

 **Note**

If a message “Agitate xx Ink” is already displayed on the control panel, the ink selection options will be changed as follows:  
 For example)  
 When “Agitate KMCY Ink” appears: “KMCYW” or “KMCY” is selectable.  
 When “Agitate W Ink” appears: “KMCYW” or “W” is selectable.  
 This is to ask you to agitate the ink as indicated by the message.

5

Tap  [Enter] key to confirm the selection so that the message asking you to agitate your selected inks will appear.

- Agitate the ink colors displayed on the control panel.
- Once you have agitated all the inks displayed, the message will disappear.



Before Use	
Setup	About Maintenance
Various Settings	Wearing protective equipment
Basic Operations	<b>Agitating ink</b>
Advanced Operations	Checking ink level and replacing ink
<b>Maintenance</b>	Empty the waste ink tank
When problems occur	Daily maintenance at the end of work
Appendix	Printer maintenance
	Replacing consumable parts
	When not using the printer for a long period of time
	Moving or transporting printer



## Agitating ink from the direct key

- 1 While either one of these messages appears on the control panel, tap  [Enter] key.

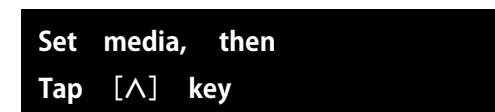

or



- 2 The time until the next ink agitation is required is displayed.
  - Using  /  key, you can check the time for Black (K), Magenta (M), Cyan (C), Yellow (Y) and White (W).

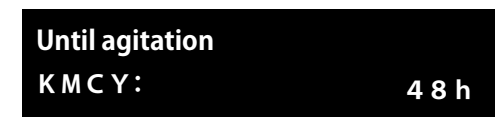



Time is shown in 1-hr increments.  
For example)

- Time for the next agitation is more than 2 hours but less than 3 hours: "2h" appears.
- Time for the next agitation is more than 1 hour but less than 2 hours: "1h" appears.
- Time for the next agitation is less than 1 hour: "<1h" appears.
- When the message "Agitate xx Ink" is already displayed: "Immediately" appears.

Before Use	
Setup	About Maintenance
Various Settings	Wearing protective equipment
Basic Operations	<b>Agitating ink</b>
Advanced Operations	Checking ink level and replacing ink
<b>Maintenance</b>	Empty the waste ink tank
When problems occur	Daily maintenance at the end of work
Appendix	Printer maintenance
	Replacing consumable parts
	When not using the printer for a long period of time
	Moving or transporting printer

3 Tap  key so that [Target ink: KMCYW] appears.



4 Use  /  key to select an ink color you want to agitate.  
 KMCYW: Select this when you want to agitate Black (K), Magenta (M), Cyan (C), Yellow (Y), White (Wh) inks.  
 KMCY: Select this when you want to agitate Black (K), Magenta (M), Cyan (C), Yellow (Y) inks.  
 W: Select this when you want to agitate White (Wh) ink.

 **Note**

If a message "Agitate xx Ink" is already displayed on the control panel, the ink selection options will be changed as follows:  
 For example)  
 When "Agitate KMCY Ink" appears: "KMCYW" or "KMCY" is selectable.  
 When "Agitate W Ink" appears: "KMCYW" or "W" is selectable.  
 This is to ask you to agitate the ink as indicated by the message.



5 Tap  [Enter] key to confirm the selection so that the message asking you to agitate your selected inks will appear.

- Agitate the ink colors displayed on the control panel.
- Once you have agitated all the inks displayed, the message will disappear.



Before Use	
Setup	About Maintenance
Various Settings	Wearing protective equipment
Basic Operations	<b>Agitating ink</b>
Advanced Operations	Checking ink level and replacing ink
<b>Maintenance</b>	Empty the waste ink tank
When problems occur	Daily maintenance at the end of work
Appendix	Printer maintenance
	Replacing consumable parts
	When not using the printer for a long period of time
	Moving or transporting printer

**You can also check the time until the next ink agitation from the Ink Agitation menu.**

**1** Tap  [Home] key so that [Menu1 Setup] appears.  
Use  /  key to choose [Menu6 Ink agitation].

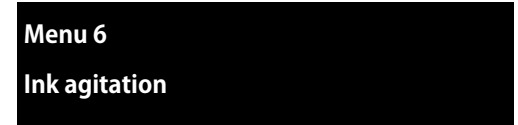

**2** Tap  key.  
The message [Ink agitation1: Perform] appears.

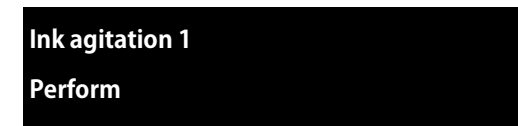

**3** Use  key to choose [Ink agitation2 Next time].



Before Use	
Setup	About Maintenance
Various Settings	Wearing protective equipment
Basic Operations	<b>Agitating ink</b>
Advanced Operations	Checking ink level and replacing ink
<b>Maintenance</b>	Empty the waste ink tank
When problems occur	Daily maintenance at the end of work
Appendix	Printer maintenance
	Replacing consumable parts
	When not using the printer for a long period of time
	Moving or transporting printer

## 4

The time until the next ink agitation is required is displayed.

- KMCY: Black (K), Magenta (M), Cyan (C), Yellow (Y)
- W: White (Wh)

Time is shown in 1-hr increments.

For example)

- Time for the next agitation is more than 2 hours but less than 3 hours: "2h" appears.
- Time for the next agitation is more than 1 hour but less than 2 hours: "1h" appears.
- Time for the next agitation is less than 1 hour: "<1h" appears.
- When the message "Agitate xx Ink" is already displayed: "Immediately" appears.

K M C Y :	4 8 h
W :	< 1 h

### Note

Tapping  key will move to the ink agitation menu.

- If you want to perform ink agitation, select "Perform".
- For details, see "[Agitating ink from "Menu 6 Ink Agitation"](#)" P.173

## 5

Once you finish checking the time, tap  key to return to the ink agitation menu.

By tapping  [Home] key the display will return to [Print Ready].

Print Ready	
H: x x x . x mm	Type 1

Before Use

Setup

Various Settings

Basic Operations

Advanced Operations

Maintenance

When problems occur

Appendix

About Maintenance

Wearing protective equipment

Agitating ink

Checking ink level and replacing ink

Empty the waste ink tank

Daily maintenance at the end of work

Printer maintenance

Replacing consumable parts

When not using the printer for a long period of time

Moving or transporting printer

## Ink agitation procedure

### Note

For proper instructions of high-capacity ink pack adapter, see the high-capacity ink pack adapter's operation manual.

1

Check that the printer is powered on.

- Remove the high-capacity ink pack adapter from the ink slot.

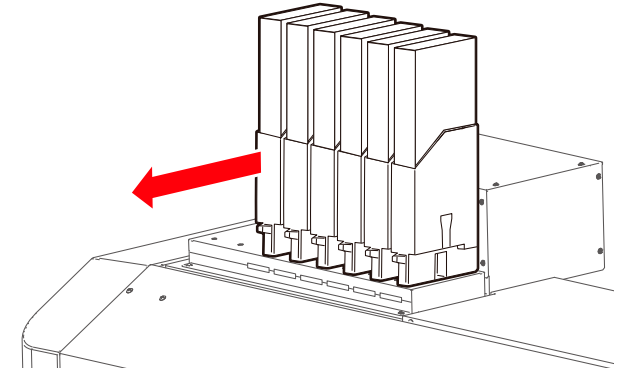

2

Using the paper towel provided with the printer, wipe off the ink around the ink outlet of the high-capacity ink pack adapter.

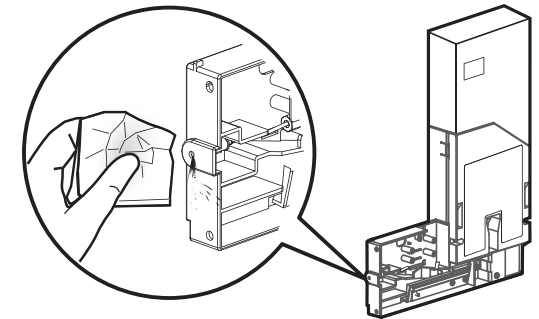

Before Use

Setup

Various Settings

Basic Operations

Advanced Operations

Maintenance

When problems occur

Appendix

About Maintenance

Wearing protective equipment

Agitating ink

Checking ink level and replacing ink

Empty the waste ink tank

Daily maintenance at the end of work

Printer maintenance

Replacing consumable parts

When not using the printer for a long period of time

Moving or transporting printer

3

Tilt the adapter and absorb the ink dripping off the adapter using a cleaning stick.

- Tilt it with the ink outlet slightly facing down.
- When tilting the adapter, make sure that the side with the warning label attached is facing down.

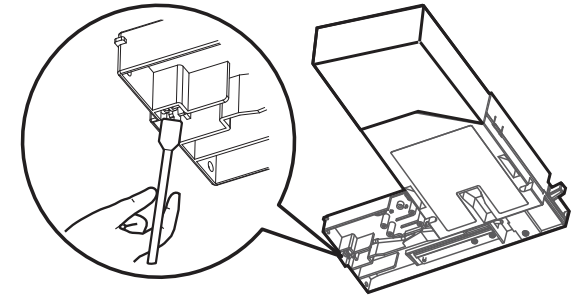

4

Hold the high-capacity ink pack adapter as shown by holding the light blocking cover down with one hand, making sure not to remove the ink bag from the adapter, and wait for three seconds.

- Then invert it and wait for three seconds.
- Repeat this 10 times.

 **Note**

There is no need to agitate varnish ink.

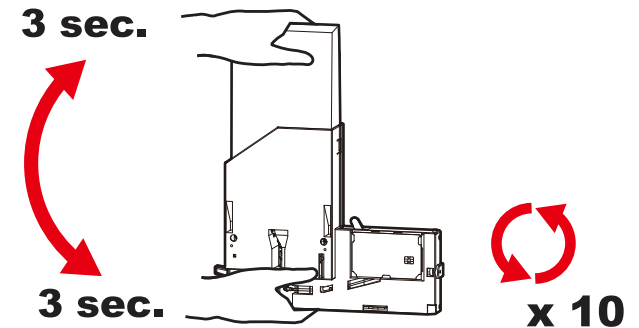

5

Insert the high-capacity ink pack adapter back to the original ink slot.

- Make sure to match the color of the ink bag with the color of the label attached to each ink slot.
- Insert it all the way in so that it is correctly seated.

 **Note**

Make sure you insert the high-capacity ink pack adapters into the original slots.

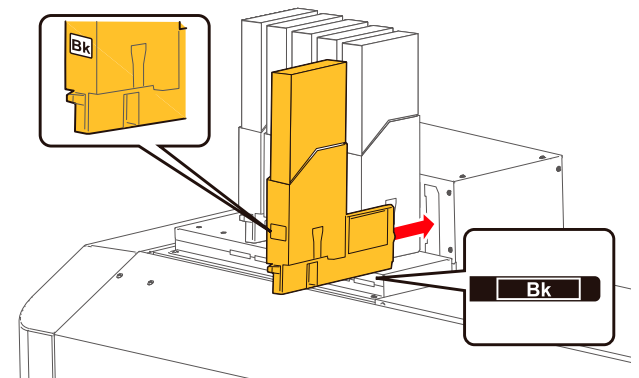

Before Use	
Setup	About Maintenance
Various Settings	Wearing protective equipment
Basic Operations	Agitating ink
Advanced Operations	Checking ink level and replacing ink
<b>Maintenance</b>	Empty the waste ink tank
When problems occur	Daily maintenance at the end of work
	Printer maintenance
Appendix	Replacing consumable parts
	When not using the printer for a long period of time
	Moving or transporting printer

# Checking ink level and replacing ink

## Check the ink level



- 1 Check the ink level indicator.
  - To see more details, tap  Home key.

### Note

You can also check the ink level on the MSM remote panel.

 ["Open MSM" P.94](#)



- 2 Tap  key several times to select [Menu 4 Printer Status].
  - Tap  key.

- 3 [Printer Status1 Ink] appears.
  - Tap  key.

- 4 The ink level of each ink bag in Slot 1 to Slot 6 is displayed in percentage (0% to 100%).

### Note

If the ink level blinks at 10 percent, the smartchip recovery is being performed on the corresponding ink.

 ["Smartchip recovery" P.249](#)

1 2 3 4 :	100 / 90 / 80 / 70
5 6 :	100 / 90

Before Use	
Setup	About Maintenance
Various Settings	Wearing protective equipment
Basic Operations	Agitating ink
Advanced Operations	Checking ink level and replacing ink
<b>Maintenance</b>	Empty the waste ink tank
When problems occur	Daily maintenance at the end of work
	Printer maintenance
	Replacing consumable parts
	When not using the printer for a long period of time
	Moving or transporting printer

## When an ink bag is nearing replacement

When the ink level becomes low, the status light on the printer control panel blinks in red with beep sound.

### Steps

- 1 Tap  Enter key.

  - The beep sound stops.
  - The printer status and an ink level warning message appear alternately at two seconds interval. The ink level indicator of the ink bag appears or disappears at 0.5 seconds interval.
  - In this figure, the slot 5 ink bag is nearing replacement.

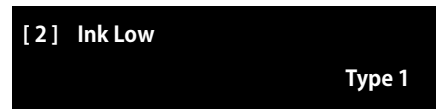

- 2 Prepare a new ink bag.

#### Note

**If it happens during sleep mode, the printer continues in sleep mode after the beep sound stops.**

Before Use	
Setup	About Maintenance
Various Settings	Wearing protective equipment
Basic Operations	Agitating ink
Advanced Operations	Checking ink level and replacing ink
<b>Maintenance</b>	Empty the waste ink tank
When problems occur	Daily maintenance at the end of work
Appendix	Printer maintenance
	Replacing consumable parts
	When not using the printer for a long period of time
	Moving or transporting printer

## Replace with a new ink bag

When the ink bag has run out of ink, the status light on the printer control panel turns on red with beep sound and printing is paused. Replacing with a new ink bag will resume printing.

### Important!

- If the printer is powered off, do not replace with a new ink bag. The printer may not be able to detect ink level correctly.
- If you do not have a new ink bag for replacement, leave the old one installed. Leaving the printer without ink bags installed could cause nozzle clogging.
- When moving an ink bag from cold place to warm place, rest it in room temperature at least 3 hours before use.

### ! Make sure to read the following sections before this task.

- ☞ "Electrical shock hazard / Fire hazard" P.10
- ☞ "Handling" P.13
- ☞ "Ink and waste fluid" P.15

## Ink replacement procedure

### Remove the high-capacity ink pack adapter

- 1 Tap  Enter key.
  - The beep sound stops.
  - In this figure, the ink bags in Slot 1 and Slot 6 need replacement.

### Note

If it happens during sleep mode, the printer continues in sleep mode after the beep sound stops.

[ 1 6 ] Ink End

Ink End



Before Use	
Setup	About Maintenance
Various Settings	Wearing protective equipment
Basic Operations	Agitating ink
Advanced Operations	Checking ink level and replacing ink
<b>Maintenance</b>	Empty the waste ink tank
When problems occur	Daily maintenance at the end of work
Appendix	Printer maintenance
	Replacing consumable parts
	When not using the printer for a long period of time
	Moving or transporting printer

**2** Remove the high-capacity ink pack adapter of the ink bag to be replaced.

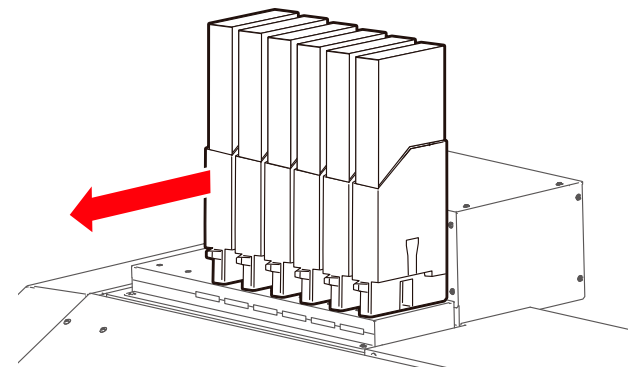

**3** Remove the light-blocking cover.

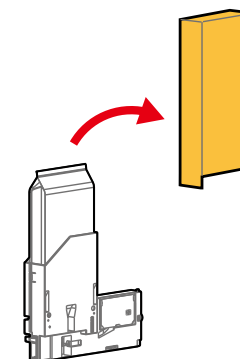

**4** Remove the empty ink bag while lowering the lock lever on the high-capacity ink pack adapter.

**Note**

Put the empty ink bag in a plastic bag and dispose of it according to the local regulations.

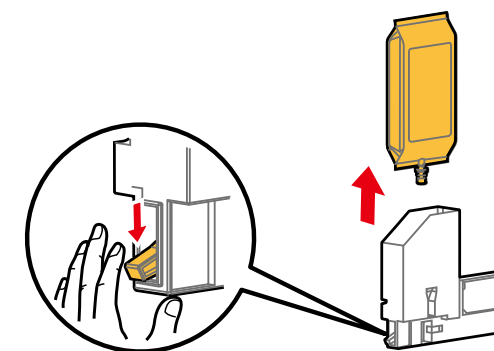

Before Use

Setup

Various Settings

Basic Operations

Advanced Operations

Maintenance

When problems occur

Appendix

About Maintenance

Wearing protective equipment

Agitating ink

Checking ink level and replacing ink

Empty the waste ink tank

Daily maintenance at the end of work

Printer maintenance

Replacing consumable parts

When not using the printer for a long period of time

Moving or transporting printer

- 5 Remove the smartchip card from the card slot.

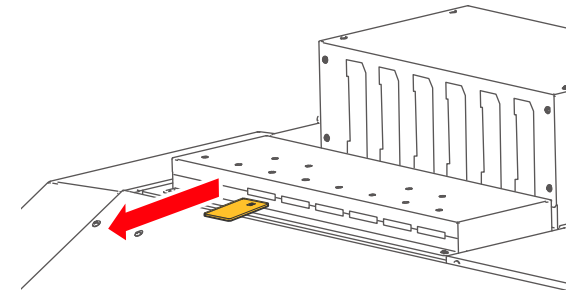

## Load a new ink bag

- 1 Prepare a new ink bag and follow the instructions below to agitate ink.
- Hold the ink bag with the ink outlet facing up and wait for three seconds.
  - Invert it so that the ink outlet is facing down and wait for three seconds.
  - Repeat this ten times (white ink : twenty times).

### Note

There is no need to agitate varnish ink.

3 sec.



- 2 Insert the new ink bag while lowering the lock lever on the high-capacity ink pack adapter.
- Insert the ink bag all the way in to seat properly.

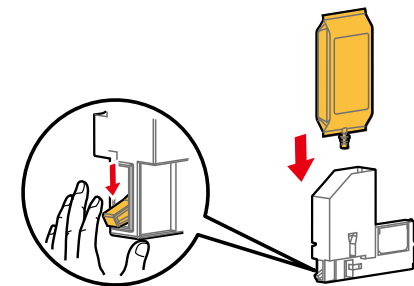

Before Use	
Setup	About Maintenance
Various Settings	Wearing protective equipment
Basic Operations	Agitating ink
Advanced Operations	Checking ink level and replacing ink
<b>Maintenance</b>	Empty the waste ink tank
When problems occur	Daily maintenance at the end of work
Appendix	Printer maintenance
	Replacing consumable parts
	When not using the printer for a long period of time
	Moving or transporting printer

**3** Ensure that the ink bag is fully seated and locked.

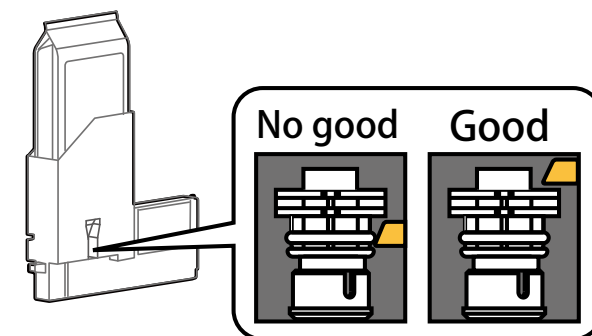

**4** Check that the lock lever of the high-capacity ink pack adapter is back to its original position.

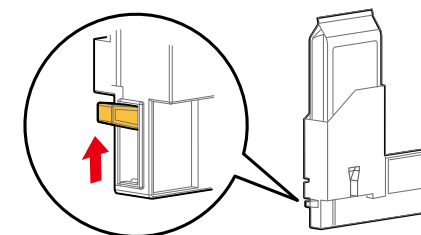

**5** Cover the ink bag with the light-blocking cover.

**Note**  
Attach it so that the light-blocking cover comes inside the high-capacity ink pack adapter.

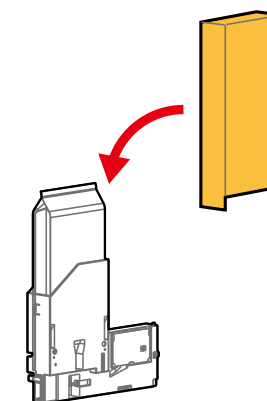

Before Use

Setup

Various Settings

Basic Operations

Advanced Operations

Maintenance

When problems occur

Appendix

About Maintenance

Wearing protective equipment

Agitating ink

Checking ink level and replacing ink

Empty the waste ink tank

Daily maintenance at the end of work

Printer maintenance

Replacing consumable parts

When not using the printer for a long period of time

Moving or transporting printer

6

Insert the high-capacity ink pack adapter into the ink slot.

- Make sure to match the color of the ink bag with the color of the label attached to each ink slot.
- Insert it all the way in so that it is correctly seated.

**Important!**

Make sure you insert the high-capacity ink pack adapters into the original slots.

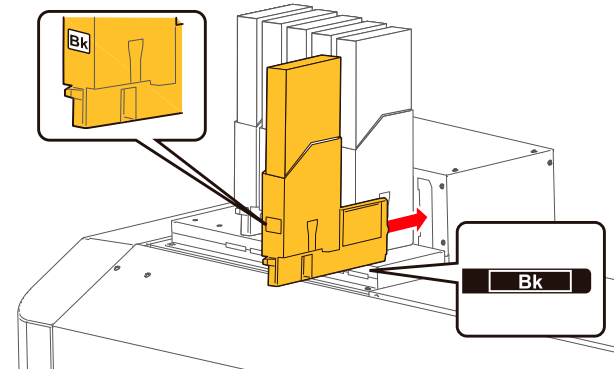

7



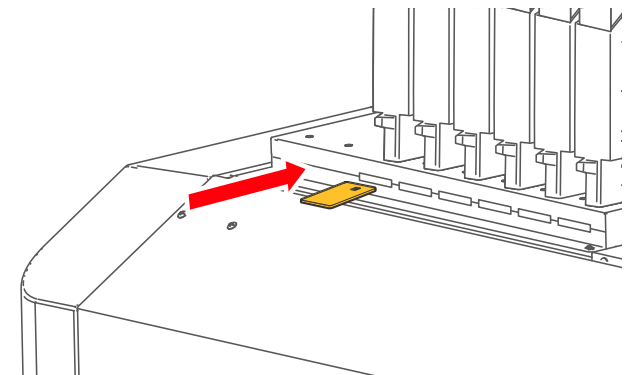

Insert a smartchip card into the card slot.



Before Use	
Setup	About Maintenance
Various Settings	Wearing protective equipment
Basic Operations	Agitating ink
Advanced Operations	Checking ink level and replacing ink
<b>Maintenance</b>	Empty the waste ink tank
When problems occur	Daily maintenance at the end of work
	Printer maintenance
	Replacing consumable parts
	When not using the printer for a long period of time
	Moving or transporting printer

## Replace the adapter's plug for high-capacity ink pack adapter

When the life of the plug ends, the message will appear. Follow these steps to replace with a new plug.

- 1 When [[1] Change Plug OK -> Enter] appears, tap  Enter key.
  - The number in parentheses identifies the slot number.
- 2 The message [[1] Change Plug] appears.
- 3 Follow the instructions in the high-capacity ink pack adapter's operation manual to replace with a new plug.
  -  **High-capacity Ink Pack Adapter Operation Manual "3.3 Replacing Adapter's Plug"**
- 4 When you inserted the high-capacity ink pack adapter into the ink slot after replacement, the message [[1] Plug Changed? No] appears.
  - Tap  key.
- 5 The message [[1] Plug Changed? Yes] appears.
  - Tap  Enter key.
  - The lifetime counter of the adapter's plug will be reset.

### Important!

If you do not replace the plug, do not choose "Yes". Using the high-capacity ink pack adapter without replacing the plug can cause ink leakage.

Before Use

Setup

Various Settings

Basic Operations

Advanced Operations

**Maintenance**

When problems occur

Appendix

About Maintenance

Wearing protective equipment

Agitating ink

Checking ink level and replacing ink

**Empty the waste ink tank**

Daily maintenance at the end of work

Printer maintenance

Replacing consumable parts

When not using the printer for a long period of time

Moving or transporting printer

# Empty the waste ink tank

When the following message appears, empty the waste ink tank.

Warning message

Empty Waste Ink Tank  
then Tap Enter

Appears periodically. Empty the waste ink tank.

- After emptying the tank, tap  Enter key so that the display returns to the previous menu.

Full WasteInkTank

The status light on the printer control panel turns on red with beep sound. Immediately empty the waste ink tank.

- Printing and other operation will stop.



**Make sure to read the following sections before this task.**

 ["Handling" P.13](#)

 ["Ink and waste fluid" P.15](#)



**Warning**

- Use a HDPE container with light blocking properties to store waste liquid.
- When storing waste fluid for a long time, slightly loosen the cap on the container to allow air. Do not tightly close it.

**1**

Use the Print /Media Set switch on the vacuum control panel to set to [Media Set].

- The Print LED will turn off.

 ["Select Print/Media Set" P.39](#)

Before Use

Setup

Various Settings

Basic Operations

Advanced Operations

Maintenance

When problems occur

Appendix

About Maintenance

Wearing protective equipment

Agitating ink

Checking ink level and replacing ink

Empty the waste ink tank

Daily maintenance at the end of work

Printer maintenance

Replacing consumable parts

When not using the printer for a long period of time

Moving or transporting printer

2

Prepare a container to collect waste ink.

**Important!**

The capacity of the waste ink tank is 2,000 ml. Make sure to prepare a container that has enough capacity.

**Note**

If no or small amount of waste fluid is collected in the waste ink tank, you may not be able to drain fluid out of the tank.

3

Cover the floor under the waste ink tank with waste paper or cloth.

4

Wear the rubber gloves over the polyethylene gloves. Wear protective equipment such as goggles, protective mask, protective clothing.

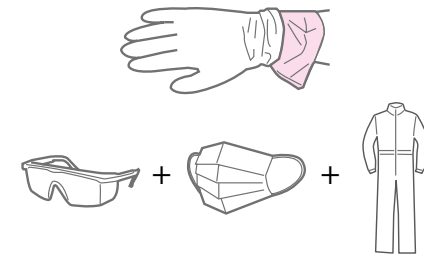

5

Open the cover of the waste ink valve case, and then take the drain tube valve out from the case.

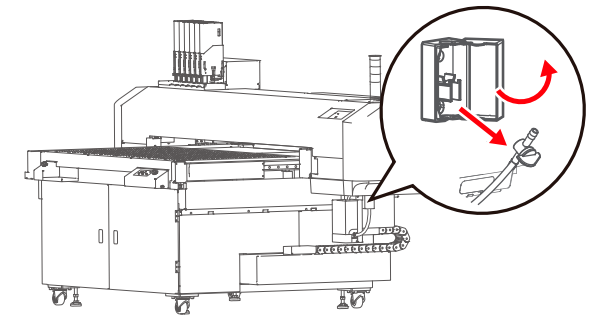

Before Use

Setup

Various Settings

Basic Operations

Advanced Operations

Maintenance

When problems occur

Appendix

About Maintenance

Wearing protective equipment

Agitating ink

Checking ink level and replacing ink

Empty the waste ink tank

Daily maintenance at the end of work

Printer maintenance

Replacing consumable parts

When not using the printer for a long period of time

Moving or transporting printer

6

Put the tip of the drain tube valve in the empty container and open the valve to drain waste ink from the waste ink tank.

**Important!**

Waste ink may splash while draining from the waste ink tank. Make sure to put the tip of the drain tube valve in the empty container to drain.

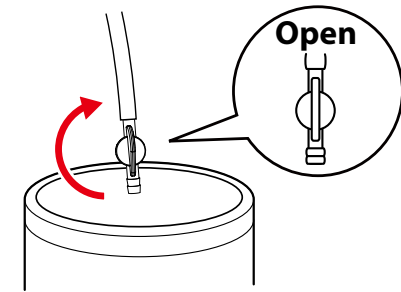

7

Once you finish emptying the tank, close the drain tube valve firmly.

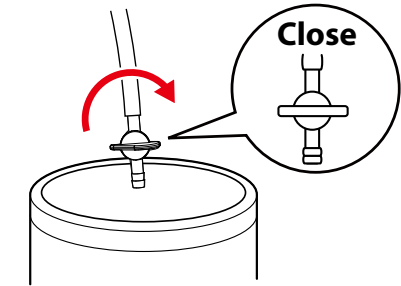

8

Use a dry cloth to clean the tip of the valve.

9

Hook the drain tube valve on the clamp of the waste ink valve case, then close the cover.

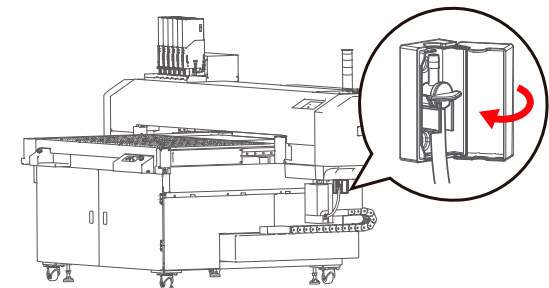

Before Use	
Setup	About Maintenance
Various Settings	Wearing protective equipment
Basic Operations	Agitating ink
Advanced Operations	Checking ink level and replacing ink
<b>Maintenance</b>	<b>Empty the waste ink tank</b>
When problems occur	Daily maintenance at the end of work
Appendix	Printer maintenance
	Replacing consumable parts
	When not using the printer for a long period of time
	Moving or transporting printer

**10** Dispose of the waste fluids as industrial waste.

**11** When [Empty Waste Ink Tank then Tap Enter] was displayed:

- After emptying the tank, tap  Enter key.
- The display will return to the previous menu.

When [Full Waste Ink Tank] was displayed:

- After emptying the tank, the printer will resume operation.

**12** Press the Print / Media Set switch on the vacuum control panel to set to [Print].

- The Print LED will turn on.

 ["Select Print/Media Set" P.39](#)



## WARNING



- You are obligated to properly dispose of waste fluid from the printer in compliance with Wastes Disposal and Public Cleansing Act and local ordinances. Delegate disposal to an industrial waste disposal contractor.
- Waste fluid from this printer is harmful to aquatic organisms. Do not allow it to reach sewage or natural water systems.

Before Use	
Setup	About Maintenance
Various Settings	Wearing protective equipment
Basic Operations	Agitating ink
Advanced Operations	Checking ink level and replacing ink
<b>Maintenance</b>	Empty the waste ink tank
	<b>Daily maintenance at the end of work</b>
When problems occur	Printer maintenance
Appendix	Replacing consumable parts
	When not using the printer for a long period of time
	Moving or transporting printer

# Daily maintenance at the end of work

**!** Make sure to read the following sections before this task.

 ["Handling" P.13](#)

 ["Ink and waste fluid" P.15](#)

This printer requires daily maintenance. Follow these steps to perform a daily maintenance when you are done printing for the day.

- The message [Perform Daily Maint.] is prompted on the control panel after a certain period of time passed from the last daily maintenance. Make sure to perform a daily maintenance when prompted.

## Important!

Even when you are printing all day long without entering to sleep mode, make sure to perform a daily maintenance once a day.

Failure to do so could cause print defects or printer failure.

To perform a daily maintenance without entering to sleep mode or powering off, go to [Maintenance10: Daily Maintenance].

 ["Cleaning each part of the printer" P.209](#)

Before Use	
Setup	About Maintenance
Various Settings	Wearing protective equipment
Basic Operations	Agitating ink
Advanced Operations	Checking ink level and replacing ink
<b>Maintenance</b>	Empty the waste ink tank
When problems occur	<b>Daily maintenance at the end of work</b>
Appendix	Printer maintenance
	Replacing consumable parts
	When not using the printer for a long period of time
	Moving or transporting printer

## Daily maintenance flow

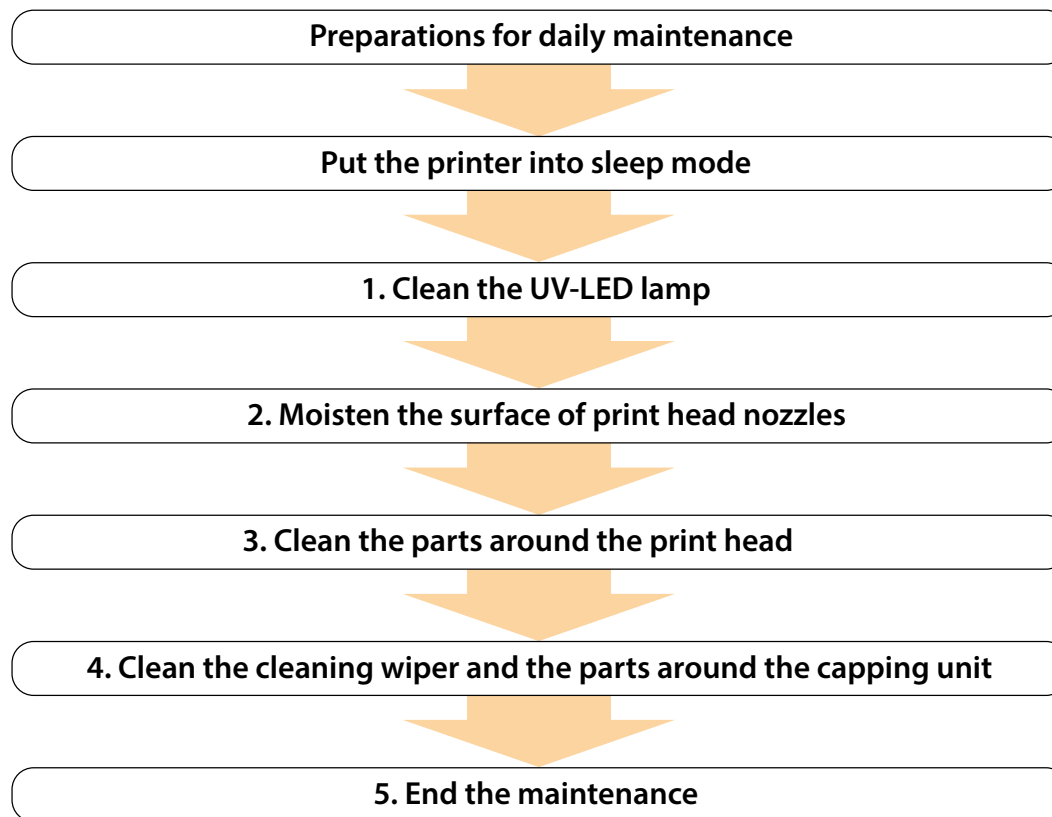

Before Use

Setup

Various Settings

Basic Operations

Advanced Operations

Maintenance

When problems occur

Appendix

About Maintenance

Wearing protective equipment

Agitating ink

Checking ink level and replacing ink

Empty the waste ink tank

Daily maintenance at the end of work

Printer maintenance

Replacing consumable parts

When not using the printer for a long period of time

Moving or transporting printer

## Preparations for daily maintenance

### What you need

1 Prepare the following items for daily maintenance.



polyethylene gloves



rubber gloves



protective goggles

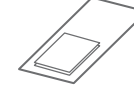

paper towel or polyester knit wiper



dropper



protective mask



designated maintenance cleaner



plastic cup

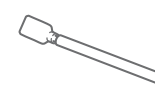

cleaning stick

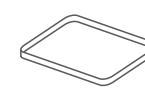

tray



scraper



protective clothing

#### Important!







- Use a paper towel supplied with the printer or optional polyester knit wiper.
- Do not use a tissue. Lint or flakes on tissue may cause damage to the print head.
- Do not use non-designated maintenance cleaner.
- To purchase the optional accessories such as designated maintenance cleaner, contact your local MUTOH dealer.

2 Wear the rubber gloves over the polyethylene gloves. Wear protective equipment such as goggle, protective mask, protective clothing.



Before Use	
Setup	About Maintenance
Various Settings	Wearing protective equipment
Basic Operations	Agitating ink
Advanced Operations	Checking ink level and replacing ink
<b>Maintenance</b>	Empty the waste ink tank
When problems occur	<b>Daily maintenance at the end of work</b>
Appendix	Printer maintenance
	Replacing consumable parts
	When not using the printer for a long period of time
	Moving or transporting printer

## Put the printer into sleep mode

- 1 Go to the "Sleep mode" menu.
  - Tap  Home key → [Menu1 Setup] appears.
  - Tap  key several times and select [Menu6 Sleep Mode].
- 2 Tap  key twice.
- 3 When [Sleep Mode1 Start] appears, tap  key.
- 4 When [Daily Maintenance Start ->Enter] appears, tap  Enter key.
  - [Please wait] appears.
- 5 When [Unload Media then Tap Enter] appears, remove media and the jig and tap  Enter key.
  - [Please wait] appears.
  - The gantry and the carriage will move to the maintenance position.

### Important!

If any obstacle is detected, the message [Unload Media then Tap Enter] will appear again. Remove media and the jig, and tap  Enter key.

- 6 When [Daily Maintenance End ->Enter] appears, you can start maintenance.
  - 👉 "Perform a daily maintenance" P.197

### Important!

The standard daily maintenance time is about 5 minutes.

Before Use

Setup

Various Settings

Basic Operations

Advanced Operations

**Maintenance**

When problems occur

Appendix

About Maintenance

Wearing protective equipment

Agitating ink

Checking ink level and replacing ink

Empty the waste ink tank

**Daily maintenance at the end of work**

Printer maintenance

Replacing consumable parts

When not using the printer for a long period of time

Moving or transporting printer

## Perform a daily maintenance

### 1. Clean the UV-LED lamp



#### CAUTION



The UV-LED lamp may get hot after printing.  
Allow the lamp to cool down for 10 minutes after printing and then start maintenance.

1

Open the front cover.

- Place the tray directly under the print head to protect the table.

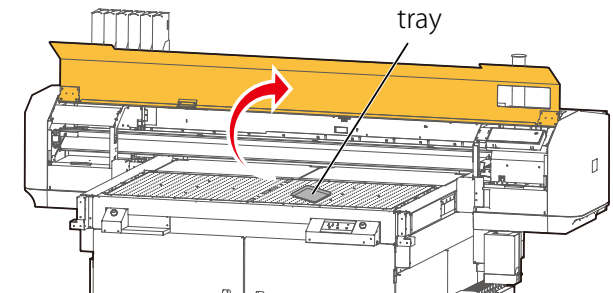

2

Look at the bottom of the UV-LED lamp and wipe off any dust or ink with a paper towel.

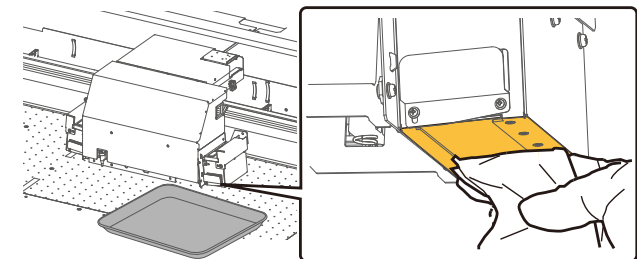

Before Use

Setup

Various Settings

Basic Operations

Advanced Operations

Maintenance

When problems occur

Appendix

About Maintenance

Wearing protective equipment

Agitating ink

Checking ink level and replacing ink

Empty the waste ink tank

Daily maintenance at the end of work

Printer maintenance

Replacing consumable parts

When not using the printer for a long period of time

Moving or transporting printer

3

If the ink cannot be removed completely, remove the emitting window glass from the lamp and use the supplied scraper to clean it off.

1. Slide up the left side of the exhaust fan cover. The right side screw serves as a fulcrum.
2. Slide the glass attached on the bottom of the lamp towards the front to remove it.
3. Press the scraper on the ink deposits with a slight angle and scrape it off.
4. Use the paper towel to clean the ink scraped from the glass.
5. Put the glass back on the lamp.
6. Firmly slide it into the end and then put the exhaust fan cover back in place.

**Important!**

- Make sure to use the scraper supplied with the printer.
- Do not press the edge of the scraper too hard. This will cause damage to the glass.
- Make sure that the emitting window glass is attached to the lamp and the exhaust fan cover is put back in place. Using your printer without them will cause damage to the lamp.

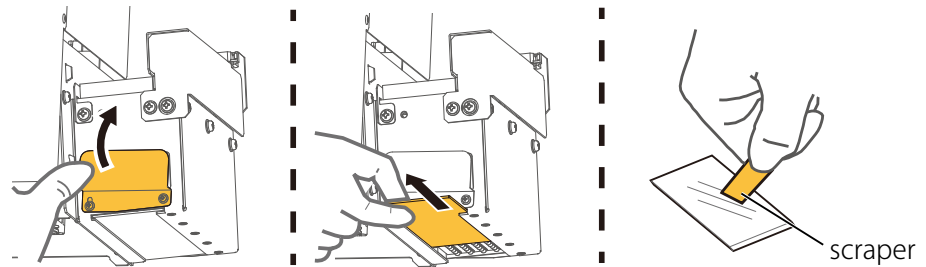

4

Next moisten the surface of print head nozzles.

Before Use

Setup

Various Settings

Basic Operations

Advanced Operations

**Maintenance**

When problems occur

Appendix

About Maintenance

Wearing protective equipment

Agitating ink

Checking ink level and replacing ink

Empty the waste ink tank

**Daily maintenance at the end of work**

Printer maintenance

Replacing consumable parts

When not using the printer for a long period of time

Moving or transporting printer

## 2. Moisten the surface of print head nozzles

### Important !

When cleaning, make sure the following points:

- Ensure to follow the instructions to perform cleaning. When moistening the surface of nozzles, do not reuse the cleaning stick already used to clean the print head circumference, cleaning wiper or capping unit circumference. This could cause damage to the print head.
- Always use a new cleaning stick and dampen it with designated maintenance cleaner. Do not use non-designated maintenance cleaner. It may cause nozzle clogging.
- Do not touch the tip of cleaning stick with fingers. If sebum gets on the stick, it will damage the print head.
- Do not reuse the used cleaning stick. Dust on the stick could cause damage to the print head.

- 1** Put a new cleaning stick in a plastic cup and use the dropper to drop the designated maintenance cleaner on the tip of the cleaning stick.(Use about 0.5 ml)



- 2** Look at the bottom side of the carriage. Using the cleaning stick dampened with the maintenance cleaner, moisten the surface of the print head nozzles.

- Lightly touch with the cleaning stick to moisten the nozzle surface.
- Repeat it a couple of times to moisten the entire nozzle surface.

### Important !

- Never rub against the nozzle surface. This could cause damage to the print head.
- When the entire nozzle surface has been moistened, you can stop it.

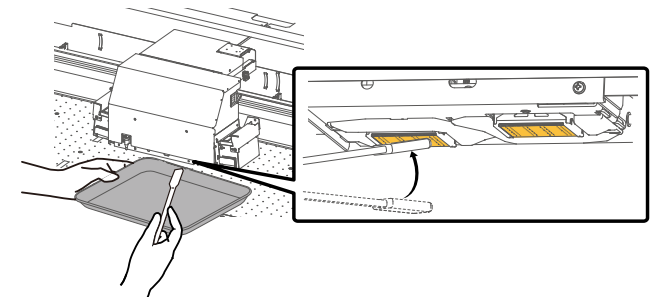

Before Use

Setup

Various Settings

Basic Operations

Advanced Operations

Maintenance

When problems occur

Appendix

About Maintenance

Wearing protective equipment

Agitating ink

Checking ink level and replacing ink

Empty the waste ink tank

Daily maintenance at the end of work

Printer maintenance

Replacing consumable parts

When not using the printer for a long period of time

Moving or transporting printer

3

Next clean the parts around the print head.

### 3. Clean the parts around the print head

1

Look at the bottom of the carriage and use the cleaning stick to clean the ink or dust on the parts shown in the illustration.

 Clean this part  Do not touch the nozzle surface (yellow)

The parts around the nozzle surface (silver metal)

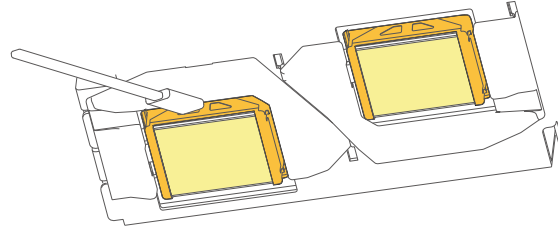

The print head guide (black plastic parts)

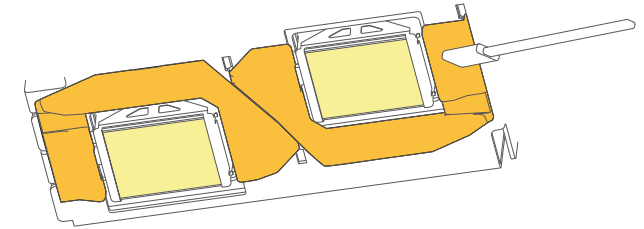

 Important!

If the maintenance cleaner is splashed on the printer, use a paper towel to wipe it off.

2

Next clean the cleaning wiper and the parts around the capping unit.

 Important!

- If the ink or dust is on the cleaning stick during cleaning, submerge the stick into the maintenance cleaner in the plastic cup.
- If the dirt does not get off, replace with a new cleaning stick and move to the next step.

Before Use

Setup

Various Settings

Basic Operations

Advanced Operations

**Maintenance**

When problems occur

Appendix

About Maintenance

Wearing protective equipment

Agitating ink

Checking ink level and replacing ink

Empty the waste ink tank

**Daily maintenance at the end of work**

Printer maintenance

Replacing consumable parts

When not using the printer for a long period of time

Moving or transporting printer

## 4. Clean the cleaning wiper and the parts around the capping unit

- 1 Slowly open the maintenance cover.

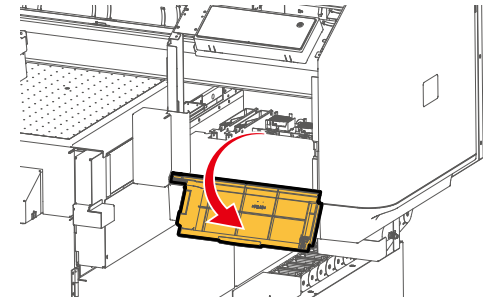

- 2 Use the cleaning stick to clean the left side of the cleaning wiper (black rubber).

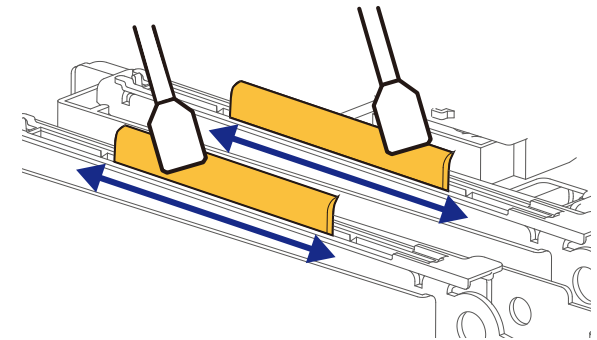

- 3 Use the cleaning stick to clean the right side of the wiper.

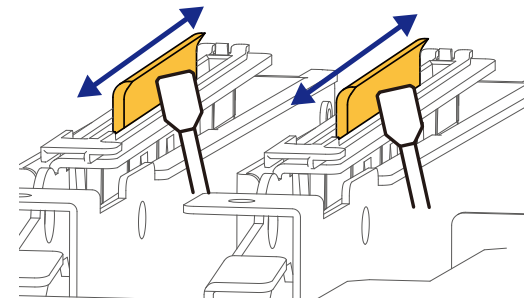

Before Use

Setup

Various Settings

Basic Operations

Advanced Operations

Maintenance

When problems occur

Appendix

About Maintenance

Wearing protective equipment

Agitating ink

Checking ink level and replacing ink

Empty the waste ink tank

Daily maintenance at the end of work

Printer maintenance

Replacing consumable parts

When not using the printer for a long period of time

Moving or transporting printer

4

Use the cleaning stick to clean the parts around the capping unit to remove ink and dust.

 Clean this part

 Do not touch the absorbent pad (yellow)

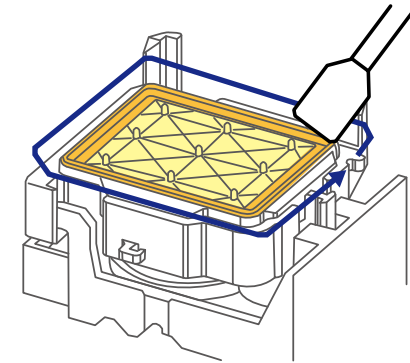

5

Slowly close the maintenance cover and the front cover.  
Next end the daily maintenance.

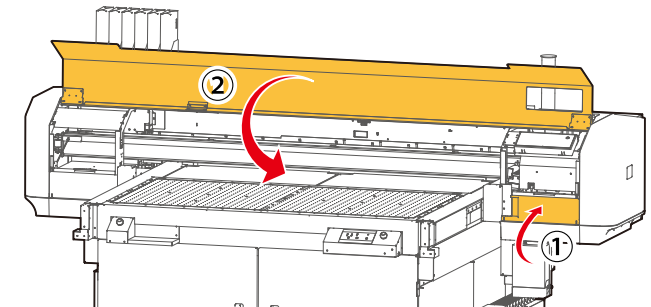

## 5. End the maintenance

1

Check that [Daily Maintenance End -> Enter] appears on the printer control panel.

- Tap  Enter key.
- The printer automatically performs a "Short" cleaning.
- Once the cleaning is complete, the printer automatically enters to sleep mode.

Before Use	
Setup	About Maintenance
Various Settings	Wearing protective equipment
Basic Operations	Agitating ink
Advanced Operations	Checking ink level and replacing ink
<b>Maintenance</b>	Empty the waste ink tank
When problems occur	<b>Daily maintenance at the end of work</b>
Appendix	Printer maintenance
	Replacing consumable parts
	When not using the printer for a long period of time
	Moving or transporting printer

## 2

- Dispose of the used cleaning stick.
- Use a paper towel to wipe the maintenance cleaner off the dropper.
- Dispose of the maintenance cleaner in the plastic cup and dry the cup well using the paper towel.
- Use a paper towel to clean the tray.

### Important!

- Do not reuse the used cleaning stick. Dust on the stick could cause damage to the print head.
- Check that the lid of the maintenance cleaner is shut properly and store it.

## 3

End the daily maintenance.

### Note

**Used cleaning stick and the maintenance cleaner left in the plastic cup are industrial waste. Dispose of them in accordance with the local regulations.**

Before Use

Setup

Various Settings

Basic Operations

Advanced Operations

**Maintenance**

When problems occur

Appendix

About Maintenance

Wearing protective equipment

Agitating ink

Checking ink level and replacing ink

Empty the waste ink tank

Daily maintenance at the end of work

**Printer maintenance**

Replacing consumable parts

When not using the printer for a long period of time

Moving or transporting printer

# Printer maintenance





## Head cleaning

If there are missing lines in the nozzle check print, perform a head cleaning.

This cleaning consumes ink.

There are several cleaning modes available in this product.

Select an appropriate mode depending on your usage conditions.

Short cleaning	Consumes less ink than "Normal" cleaning.
Normal cleaning	Select this mode if there are several missing lines in the nozzle check print.
Long cleaning	Consumes more ink than "Normal" cleaning. Perform "Long" cleaning if nozzle clogging persists even if "Normal" cleaning was performed.
Little Charge	Gives higher cleaning than "Long" cleaning, but consumes large amount of ink. This menu is not selectable from the  direct key. To access this menu, go to the cleaning menu of the maintenance menu.  <b>"Maintenance menu" P.126</b>
Initial Charge:	Offers more powerful cleaning than "Little Charge", but consume large amount of ink than "Little Charge". This menu is not selectable from the  direct key. To access this menu, go to the cleaning menu of the maintenance menu.  <b>"Maintenance menu" P.126</b> This menu does not appear when you perform cleaning from the maintenance menu and [Head1] or [Head2] is selected in the Select Print Head menu.

### Important!







When you perform "Little Charge" or "Initial Charge",

- Do not open the front cover and the maintenance cover.
- Make sure to install the new ink bags.

If cleaning is interrupted, it may consume more ink.

Before Use	
Setup	About Maintenance
Various Settings	Wearing protective equipment
Basic Operations	Agitating ink
Advanced Operations	Checking ink level and replacing ink
<b>Maintenance</b>	<b>Empty the waste ink tank</b>
When problems occur	Daily maintenance at the end of work
Appendix	<b>Printer maintenance</b>
	Replacing consumable parts
	When not using the printer for a long period of time
	Moving or transporting printer

## Head cleaning procedure

- 1 Check that [Print Ready Type1] appears on the control panel.
- 2 Tap  key.  
 "Direct keys" P.34
- 3 Use  /  key to select a cleaning mode.
  - Tap  Enter key.
  - The cleaning cycle begins.
- 4 Run a nozzle check print.
  - If nozzle clogging still persists, repeat cleaning and nozzle check print.
  -  "Run a nozzle check and cleaning" P.78

### Note

If missing lines still persists after several attempts of "Normal" cleaning, perform a "Long" cleaning.  
 If missing lines still persists after several attempts of "Long" cleaning, perform "Cleaning each part of the printer" P.209  
 If nozzle clogging still persists, go to  "Head cleaning" P.204 and perform "Little Charge".

Before Use	
Setup	About Maintenance
Various Settings	Wearing protective equipment
Basic Operations	Agitating ink
Advanced Operations	Checking ink level and replacing ink
<b>Maintenance</b>	Empty the waste ink tank
When problems occur	Daily maintenance at the end of work
Appendix	<b>Printer maintenance</b>
	Replacing consumable parts
	When not using the printer for a long period of time
	Moving or transporting printer

## Soak Cleaning

When to perform:

- once a week(recommended)
- nozzle clogging or nozzle deflection persists after cleaning attempt.

Preparation:





- Polyethylene gloves, rubber gloves, protective eye wear, mask
- Plastic cup, Dropper
- Designated maintenance cleaner,

**1** Wear protective equipment.  
 ["Wearing protective equipment" P. 171](#)

**2** Pour an appropriate amount of maintenance cleaner into the plastic cup.



**3** Go to the "Soak Cleaning" menu.

- Tap  [Home] key so that [Menu1 Setup] appears.
- Use  key to choose [Menu3 Maintenance].
- Tap  key [Maintenance1: Cleaning] appears.
- Use  /  key to choose [Maintenance6: Soak Cleaning].

**4** Tap  key.

- [Soak Cleaning /Start ->Enter] appears.

Before Use

Setup

Various Settings

Basic Operations

Advanced Operations

Maintenance

When problems occur

Appendix

About Maintenance

Wearing protective equipment

Agitating ink

Checking ink level and replacing ink

Empty the waste ink tank

Daily maintenance at the end of work

Printer maintenance

Replacing consumable parts

When not using the printer for a long period of time

Moving or transporting printer

5 Tap  [Enter] key.

- The carriage moves to the maintenance position (left side of the printer).

6 When [Pour Cleaning Fluid/ End -> Enter ] appears, start maintenance.

Slowly open the covers in the following order:

- ① Front cover
- ② Maintenance cover R

 **Note**

The message "Close cover" appears if the covers are open for more than ten minutes. In such cases, close all the covers and start again.

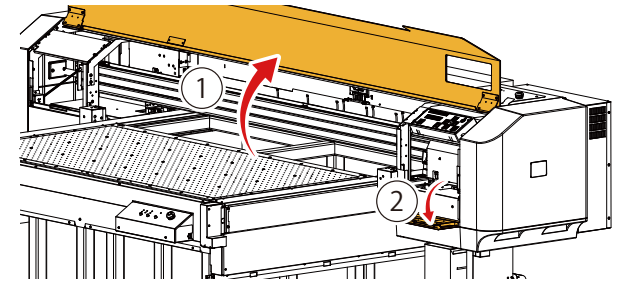

7 Fill the head cap with maintenance cleaner.

- Use a dropper to fill it with maintenance cleaner until the cleaner almost overflows the cap.

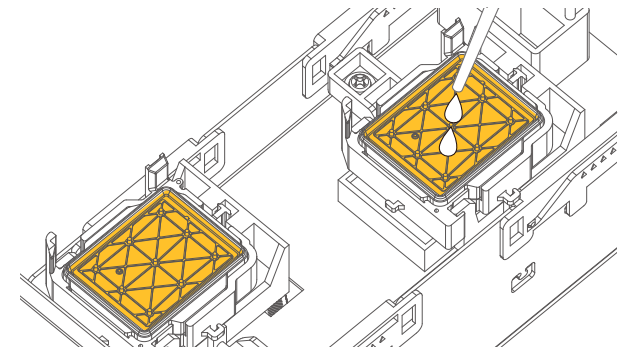

Before Use	
Setup	About Maintenance
Various Settings	Wearing protective equipment
Basic Operations	Agitating ink
Advanced Operations	Checking ink level and replacing ink
<b>Maintenance</b>	Empty the waste ink tank
When problems occur	Daily maintenance at the end of work
Appendix	<b>Printer maintenance</b>
	Replacing consumable parts
	When not using the printer for a long period of time
	Moving or transporting printer

**8** Using a paper towel, completely wipe off any ink on the surface of the air valve (parts ① and ②).

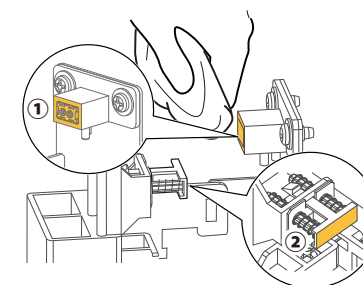

**9** Slowly close the maintenance cover R and then the front cover in order. Tap [Enter] key.

- The carriage goes back to the capping station.

**10** When [Soaking time: (1-99) 10 min] appears, use / key to specify the soaking time and then tap [Enter] key.

- The countdown begins.
- 10 minutes is recommended for soak cleaning time.

**11** When the timer reaches 0, the cleaning begins automatically.

**12** End the soak cleaning.

- Clean off the maintenance cleaner from the dropper with the paper towel.
- Dispose of the maintenance cleaner in the plastic cup and clean off the cup with the paper towel.

**Important !**

- Close the maintenance cleaner bottle tightly and store it.
- Used paper towel and the maintenance cleaner left in the plastic cup are industrial waste. Dispose of them in accordance with the local regulations.

Before Use	
Setup	About Maintenance
Various Settings	Wearing protective equipment
Basic Operations	Agitating ink
Advanced Operations	Checking ink level and replacing ink
<b>Maintenance</b>	Empty the waste ink tank
When problems occur	Daily maintenance at the end of work
Appendix	<b>Printer maintenance</b>
	Replacing consumable parts
	When not using the printer for a long period of time
	Moving or transporting printer

## Cleaning each part of the printer

You will need to clean each part of the printer when

- missing lines or thin lines still persist after head cleaning was performed.
- you are printing all day long without entering to sleep mode and need to perform a daily maintenance

Preparations:

Refer to "Preparations for  "Preparations for daily maintenance" P.195 and prepare necessary items.

### Important !

This procedure applies when you will continue to use your printer after the maintenance.

When you perform a daily maintenance at the end of the work, put the printer into sleep mode and perform a daily maintenance.

 "Daily maintenance at the end of work" P.193

## Cleaning flow





### 1. Put the printer in daily maintenance state.

1



Check that no media or jig is loaded on the table.

2

Go to the "Daily Maintenance" menu.

- Tap  Home key → [Menu1 Setup] appears.
- Tap  key several times to select [Menu 3 Maintenance].
- Tap  key. → [Maintenance1 Cleaning] appears.
- Tap  /  key several times to select [Maintenance7 Daily Maintenance].

3

Tap  key and when [Daily Maintenance Start -> Enter] appears, tap  Enter key.

Before Use	
Setup	About Maintenance
Various Settings	Wearing protective equipment
Basic Operations	Agitating ink
Advanced Operations	Checking ink level and replacing ink
<b>Maintenance</b>	<b>Empty the waste ink tank</b>
When problems occur	Daily maintenance at the end of work
Appendix	<b>Printer maintenance</b>
	Replacing consumable parts
	When not using the printer for a long period of time
	Moving or transporting printer

- 4** The message [Unload Media then Tap Enter] appears.
- Remove the media and the jig and tap  Enter key.

- 5** The message [Please Wait] appears.
- The gantry and the carriage will move to the maintenance position.

**Important !**





If any obstacle is detected, the message [Unload Media then Tap Enter] will appear again. Remove media and the jig, and tap  Enter key.

- 6** The message [Daily Maintenance End -> Enter] appears.
- You can start cleaning each part of the printer.

## 2.Clean each part of the printer

The parts you need to clean are the same as "Daily Maintenance".

Follow the instructions of  "1. Perform a daily maintenance" P.236 to clean each part.

-  "1. Clean the UV-LED lamp" P.197
-  "2. Moisten the surface of print head nozzles" P.199
-  "3. Clean the parts around the print head" P.200
-  "4. Clean the cleaning wiper and the parts around the capping unit" P.201

**Important !**

The standard daily maintenance time is about 5 minutes.

Before Use	
Setup	About Maintenance
Various Settings	Wearing protective equipment
Basic Operations	Agitating ink
Advanced Operations	Checking ink level and replacing ink
<b>Maintenance</b>	<b>Empty the waste ink tank</b>
When problems occur	Daily maintenance at the end of work
Appendix	<b>Printer maintenance</b>
	Replacing consumable parts
	When not using the printer for a long period of time
	Moving or transporting printer

## Maintenance for optional ionizer

### Warning

- Before maintenance on ionizer or replacement of electrode needle, make sure to turn off the printer. Performing these tasks with power on could lead to an electrical shock or accident.
- Do not put tools, metallic objects (e.g. wire) or fingers close to the electrode needle. This could result in an electrical shock or damage.
- Do not touch the electrode needle with hand. This may cause injury.

### Caution

- Do not touch the electrode needle with hard objects such as tools. Any damage to the needle will affect the performance of static elimination, causing an accident or failure.
- After long-term use, the dust or dirt will attach to the electrode needle. Clean it when the warning indicator light blinks. Using the ionizer with dust or dirt accumulated on the needle will reduce the performance of static elimination, causing an accident or failure. Regular cleaning (approximately once a month) is recommended.
- Depending on your environment or media being used, the ionizer may not provide sufficient effect.

## Clean the electrode needle

Follow these steps to clean the electrode needle on the ionizer.

When to clean:

- when the electrode needle gets dirty or once a month

What you need:

- Polyethylene gloves, rubber gloves, protective eye wear
- Cotton swab or cleaning kit



**1**

Wear protective equipment.

 ["Wearing protective equipment" P.171](#)

Before Use	
Setup	About Maintenance
Various Settings	Wearing protective equipment
Basic Operations	Agitating ink
Advanced Operations	Checking ink level and replacing ink
<b>Maintenance</b>	<b>Empty the waste ink tank</b>
When problems occur	Daily maintenance at the end of work
Appendix	<b>Printer maintenance</b>
	Replacing consumable parts
	When not using the printer for a long period of time
	Moving or transporting printer

**2** Remove media.

**3** Tap  key to move the gantry to the front of the printer, and then turn off the printer.  
 "Turn off the printer" P.54

**4** Open the front cover and clean the electrode needle on the ionizer. There are two cleaning methods: using cotton swab and using cleaning kit.

**[Cleaning with cotton swab]**

- Use the cotton swab dampened with alcohol to wipe the dirt off the electrode needle and its surrounding area.

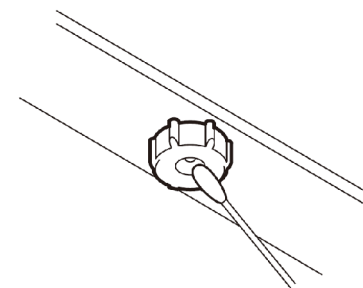

**[Cleaning using the cleaning kit]**

- (a) Dampen the filter on the cleaning kit with alcohol.
- (b) Put the cleaning kit on the electrode needle and then rotate the kit to the left and right a few times to remove the dirt with the filter.
- If the filter gets very dirty, replace with a new one and clean it again.

 "Attach a filter" P.213

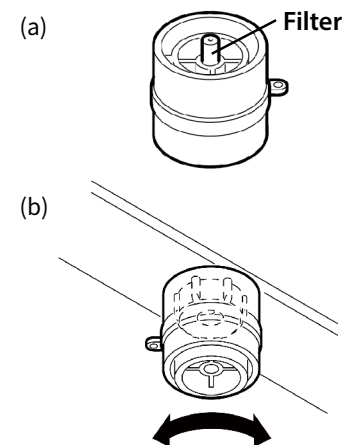

Before Use	
Setup	About Maintenance
Various Settings	Wearing protective equipment
Basic Operations	Agitating ink
Advanced Operations	Checking ink level and replacing ink
<b>Maintenance</b>	Empty the waste ink tank
When problems occur	Daily maintenance at the end of work
Appendix	<b>Printer maintenance</b>
	Replacing consumable parts
	When not using the printer for a long period of time
	Moving or transporting printer

**5** Once the cleaning has finished, close the front cover and turn on the printer.  
 ☞ "Turn on the printer" P.53

**Important !**

If the ion level warning persists after cleaning, replace with a new electrode needle. (☞ "Warning indicator light function" P.216 )

☞ "Replace with a new electrode needle" P.214

**Note**

- The cleaning kit has the caps to avoid dirt contamination. When storing the cleaning kit, make sure to cap it.
- The cleaning kit has a string hole that you can put a string and hang it to the wall. Make sure to cap it while hanging. String is not included in the kit.

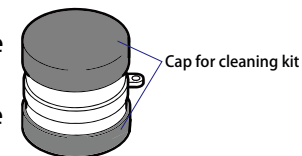

## Attach a filter

After cleaning the electrode needle several times, the filter will get dirty with dust and its cleaning performance will reduce. If the filter is dirty, replace with a new one.

**1** Remove the dirty filter and insert a new filter into the hole in the center of the cleaning kit.

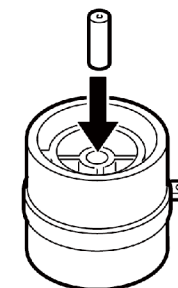

Before Use

Setup

Various Settings

Basic Operations

Advanced Operations

Maintenance

When problems occur

Appendix

About Maintenance

Wearing protective equipment

Agitating ink

Checking ink level and replacing ink

Empty the waste ink tank

Daily maintenance at the end of work

Printer maintenance

Replacing consumable parts

When not using the printer for a long period of time

Moving or transporting printer

2

Push the filter to insert it all the way.

- Make sure that the filter is not bent and is inserted all the way ( $\pm 1$  mm from the end face).

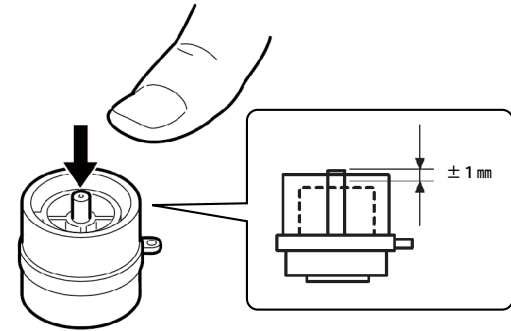

## Replace with a new electrode needle

When to replace:

- When the ion level warning appears even after cleaning or the needle has worn

What you need:

- Polyethylene gloves, rubber gloves, protective eye wear
- Designated electrode needle replacement kit
- New electrode needle

1

Wear protective equipment.

 ["Wearing protective equipment" P.171](#)

2

Remove media.

3

Tap  key to move the gantry to the front of the printer, and then turn off the printer.

 ["Turn off the printer" P.54](#)

Before Use

Setup

Various Settings

Basic Operations

Advanced Operations

Maintenance

When problems occur

Appendix

About Maintenance

Wearing protective equipment

Agitating ink

Checking ink level and replacing ink

Empty the waste ink tank

Daily maintenance at the end of work

Printer maintenance

Replacing consumable parts

When not using the printer for a long period of time

Moving or transporting printer

4

#### Replace with a new electrode needle.

- (a) Put the designated electrode needle replacement kit on the electrode needle. While pushing it against the ionizer, rotate the kit anticlockwise to remove the electrode needle.
- (b) Put the replacement kit on a new electrode needle and insert it into the slot while aligning with the groove.
- (c) While pushing it against the ionizer, rotate the kit clockwise to attach the electrode needle.

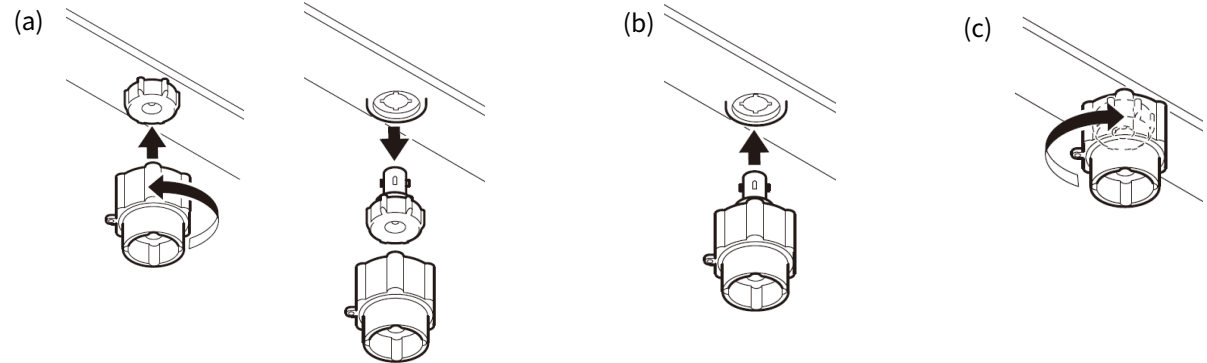

#### Important!

Observe the following caution when attaching the electrode needle.

- Align the marks on the ionizer and the electrode needle.

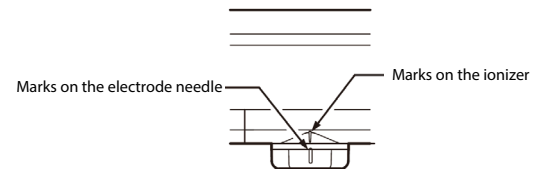

- Check that the O ring is fit into place.

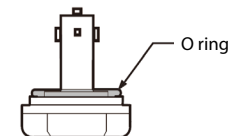

Before Use

Setup

Various Settings

Basic Operations

Advanced Operations

Maintenance

When problems occur

Appendix

About Maintenance

Wearing protective equipment

Agitating ink

Checking ink level and replacing ink

Empty the waste ink tank

Daily maintenance at the end of work

Printer maintenance

Replacing consumable parts

When not using the printer for a long period of time

Moving or transporting printer

## Warning indicator light function

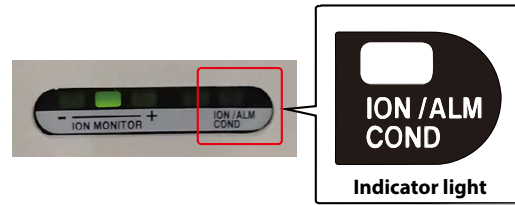

The ionizer has the warning indicator light. The ION/ALM/COND indicator blinks when a maintenance or attention is required. Warning types are as follows.

### Ionizer warning types

Warning	Indicator light	Possible cause	Solutions
Alarm(ALM)	Flash three times every seconds	<ul style="list-style-type: none"> <li>Abnormal discharge</li> <li>Internal circuit broken</li> </ul>	Please contact your MUTOH dealer you purchased from.
Ion level(ION)	Flash twice every seconds	Electrode needle became dirty or worn (it's time for maintenance)	Turn off the printer and clean the electrode needle. If the problem persists, replace with the new one. ➔ <a href="#">"Clean the electrode needle" P.211</a> ➔ <a href="#">"Replace with a new electrode needle" P.214</a>
Condition(COND)	Flash once every seconds	The performance of static elimination has been affected by the work environment (temperature, humidity, surrounding metals, etc.)	Check that the work environment is within the specification range and there is no conductive material like metals around the printer.

## Confirmation procedure

1

Go to the "Ionizer" menu.

- Tap Home key → [Menu1 Setup] appears.
- Tap key several times to select [Menu 3 Maintenance].
- Tap key. → [Maintenance1 Cleaning] appears.
- Tap / key to select [Maintenance8 Ionizer].

Before Use	
Setup	About Maintenance
Various Settings	Wearing protective equipment
Basic Operations	Agitating ink
Advanced Operations	Checking ink level and replacing ink
<b>Maintenance</b>	Empty the waste ink tank
When problems occur	Daily maintenance at the end of work
Appendix	Printer maintenance
	Replacing consumable parts
	When not using the printer for a long period of time
	Moving or transporting printer

**2** Tap [>] key. The message [Ionizer / Start => Enter] appears.

- Tap  Enter key.

**3** The message [Please wait] appears.

- The ionizer begins to remove static.
- It beeps while working.

**4** When the message [Ionizer / End => Enter] appears, open the front cover and check the [ION/ALM/COND] indicator.

- If it is blinking, the ionizer requires maintenance or some attention.  
 **"Ioniger warnig types" P.216**
- If it is turned off, the ionizer is working properly.

**5** Once you have checked, close the front cover and tap  Enter key.

**6** The message [Please wait] appears.

- The ionizer finishes removing static.
- The beep sound stops.

**7** If the indicator was blinking in step 4, take an appropriate action depending on the types of warning.

- If it is blinking, the ionizer requires maintenance or some attention.  
 **"Ioniger warnig types" P.216**



### Warning

Before maintenance on ionizer or replacement of electrode needle, make sure to turn off the printer. Performing these tasks with power on could lead to an electrical shock or accident. water systems.

Before Use

Setup

Various Settings

Basic Operations

Advanced Operations

Maintenance

When problems occur

Appendix

About Maintenance

Wearing protective equipment

Agitating ink

Checking ink level and replacing ink

Empty the waste ink tank

Daily maintenance at the end of work

Printer maintenance

Replacing consumable parts

When not using the printer for a long period of time

Moving or transporting printer

# Replacing consumable parts

In order to maintain consistent printing quality, the following parts must be replaced periodically.

Parts	When to replace
Flushing box pad	When looking from the side, the ink deposits accumulated on the flushing pad is visible through the flushing box frame. (It depends on your use frequency. Check it periodically.)
Cleaning wiper	Approximately every six months
Emitting window glass of UV-LED lamp	When the glass has cracks or a chip in the edge, or the dirt on the glass cannot be removed.
Filter of UV-LED lamp	Approximately every one month or when the filter gets dirty with ink or dust (It depends on your use frequency. Check it periodically.)
Exhaust fan filter	When the area on the filter which is normally hidden behind the filter frame is also contaminated with ink (It depends on your use frequency. Check it periodically.)
Electrode needle for optional ionizer	The warning for ion level appears even after cleaning or the electrode needle has worn.





Before Use	
Setup	About Maintenance
Various Settings	Wearing protective equipment
Basic Operations	Agitating ink
Advanced Operations	Checking ink level and replacing ink
<b>Maintenance</b>	Empty the waste ink tank
When problems occur	Daily maintenance at the end of work
Appendix	Printer maintenance
	<b>Replacing consumable parts</b>
	When not using the printer for a long period of time
	Moving or transporting printer

## Replacement flow

### 1. Put the printer in CR maintenance state

1

Go to the "CR Maintenance" menu.

- Tap  Home key → [Menu1 Setup] appears.
- Tap  key several times to select [Menu 3 Maintenance].
- Tap  key. → [Maintenance1 Cleaning] appears.
- Tap  /  key to select [Maintenance2 CR Maintenance].

2

Tap  key and when [CR Maintenance Start -> Enter] appears, tap  Enter key.





- The carriage moves to the left side of the printer.
- The message [CR Maintenance End -> Enter] appears.

3

The printer is now in the CR maintenance state. You can start replacement.

### 2. Replace consumable parts

Follow the instructions to replace each part.

-  ["Replace the flushing box pad" P.220](#)
-  ["Replace the cleaning wiper" P.224](#)
-  ["Replace the emitting window glass of the UV-LED lamp" P.227](#)
-  ["Replace the filter of UV-LED lamp" P.230](#)
-  ["Replacing and cleaning the exhaust fan filter" P.232 \\*](#)

\* (Replacement or cleaning of exhaust fan filter can be done without putting the printer into CR maintenance mode.)  
(For replacement of the ionizer's electrode needle, see ["Replace with a new electrode needle" P.214](#) .

Before Use

Setup

Various Settings

Basic Operations

Advanced Operations

Maintenance

When problems occur

Appendix

About Maintenance

Wearing protective equipment

Agitating ink

Checking ink level and replacing ink

Empty the waste ink tank

Daily maintenance at the end of work

Printer maintenance

Replacing consumable parts

When not using the printer for a long period of time

Moving or transporting printer

## Replace the flushing box pad

The flushing box is a part that collects inks spitted from the print head.

Please replace it regularly. Using your printer without replacing it could cause damage to the print head.

When to replace

- When looking from the side, the ink deposits accumulated on the flushing pad is visible through the flushing box frame. (Approximately every two months) \* It depends on your use frequency. Check it periodically.

What you need

- Polyethylene gloves, rubber gloves, protective eye wear, mask
- New flushing box pad
- Waste paper (paper that ink does not bleed through)



**Make sure to read the following sections before this task.**

👉 "Handling" P.13

👉 "Ink and waste fluid" P.15

### 1. Checking procedure

1

Open the front cover and the maintenance cover R.

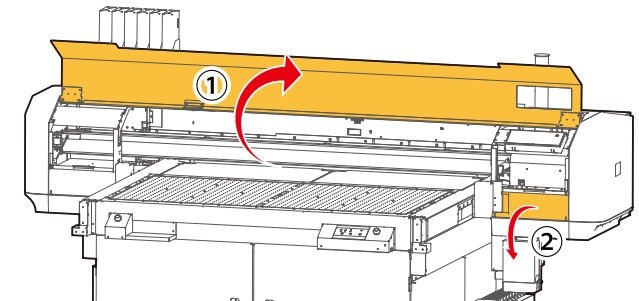

Before Use

Setup

Various Settings

Basic Operations

Advanced Operations

Maintenance

When problems occur

Appendix

About Maintenance

Wearing protective equipment

Agitating ink

Checking ink level and replacing ink

Empty the waste ink tank

Daily maintenance at the end of work

Printer maintenance

Replacing consumable parts

When not using the printer for a long period of time

Moving or transporting printer

2

Check the pad of the flushing box.

- (When looking from the side) if the ink deposits accumulated on the flushing pad is visible through the flushing box frame, you need to replace it.

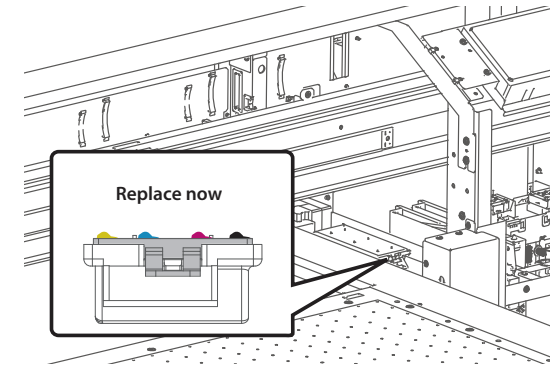

3

Close the maintenance cover R and the front cover.

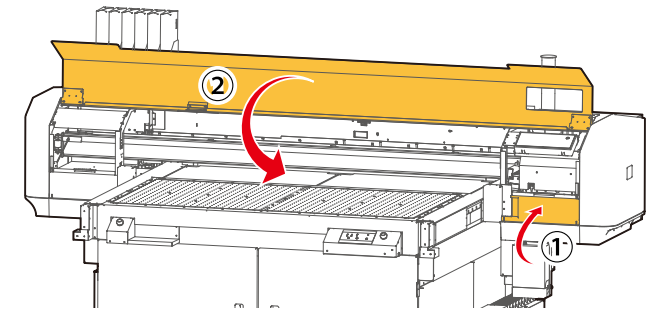

Before Use

Setup

Various Settings

Basic Operations

Advanced Operations

Maintenance

When problems occur

Appendix

About Maintenance

Wearing protective equipment

Agitating ink

Checking ink level and replacing ink

Empty the waste ink tank

Daily maintenance at the end of work

Printer maintenance

Replacing consumable parts

When not using the printer for a long period of time

Moving or transporting printer

## 2.Replacement procedure

- 1 Wear protective equipment.  
☞ "Wearing protective equipment" P.171
- 2 Put the printer in CR maintenance state.  
☞ "1.Put the printer in CR maintenance state" P.219
- 3 Open the front cover and the maintenance cover R.

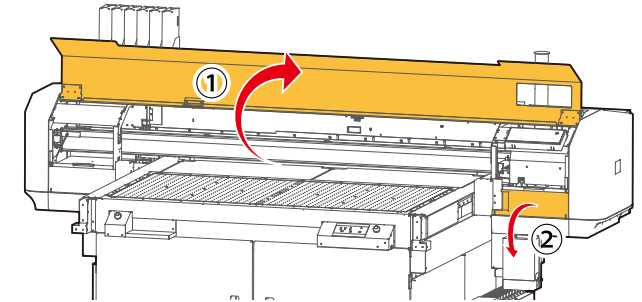

- 4 Remove the pad from the flushing box.
  - Pull the tab of the flushing box up to unhook it.

### Important!

- When removing the pad from the flushing box, be careful of ink dripping.
- Put the used pad in a plastic bag and dispose of it according to the local regulations.

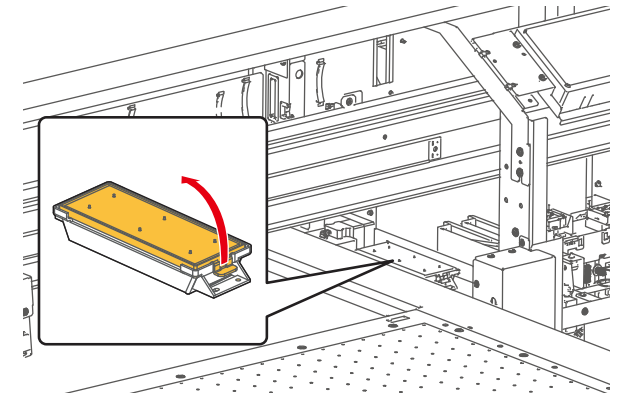

Before Use

Setup

Various Settings

Basic Operations

Advanced Operations

Maintenance

When problems occur

Appendix

About Maintenance

Wearing protective equipment

Agitating ink

Checking ink level and replacing ink

Empty the waste ink tank

Daily maintenance at the end of work

Printer maintenance

Replacing consumable parts

When not using the printer for a long period of time

Moving or transporting printer

5

Attach a new pad to the flushing box.

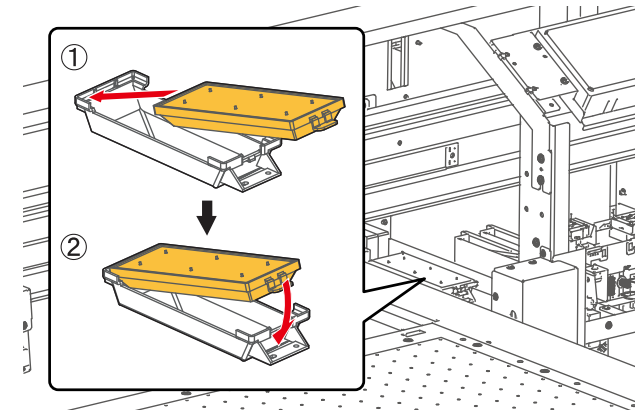

6

Close the maintenance cover R and the front cover.

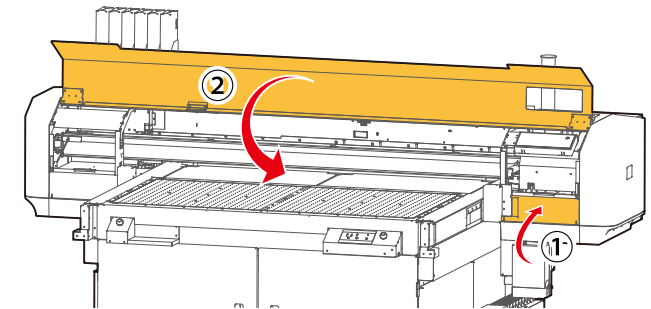

7

Check that [CR Maintenance End -> Enter] appears on the control panel and tap  Enter key.

- The message [CR Maintenance Start -> Enter] appears.
- The procedure ends here.

Before Use

Setup

Various Settings

Basic Operations

Advanced Operations

Maintenance

When problems occur

Appendix

About Maintenance

Wearing protective equipment

Agitating ink

Checking ink level and replacing ink

Empty the waste ink tank

Daily maintenance at the end of work

Printer maintenance

Replacing consumable parts

When not using the printer for a long period of time

Moving or transporting printer

## Replace the cleaning wiper

The cleaning wiper is an essential part to ensure consistent printing quality. Please replace it periodically.

When to replace :

- Approximately every twelve months

What you need

- Polyethylene gloves, protective eye wear, mask
- New cleaning wiper
- Waste paper (paper that ink does not bleed through)



**Make sure to read the following sections before this task.**

"Handling" P.13

"Ink and waste fluid" P.15

## Replacement procedure

1

Wear protective equipment.

"Wearing protective equipment" P.171

2

Put the printer in CR maintenance state.

"1.Put the printer in CR maintenance state" P.219

3

Open the front cover and the maintenance cover R.

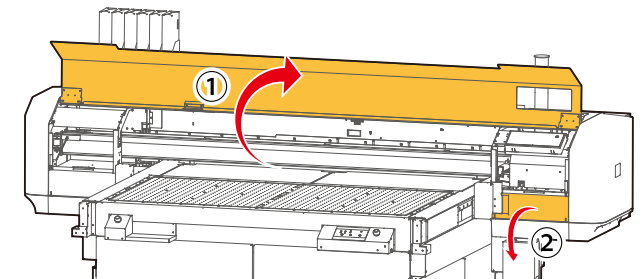

Before Use

Setup

Various Settings

Basic Operations

Advanced Operations

Maintenance

When problems occur

Appendix

About Maintenance

Wearing protective equipment

Agitating ink

Checking ink level and replacing ink

Empty the waste ink tank

Daily maintenance at the end of work

Printer maintenance

Replacing consumable parts

When not using the printer for a long period of time

Moving or transporting printer

4

Remove the cleaning wiper.

- Slide the hook on the wiper to the back to unhook from the wiper slot.
- Lift the hook and remove the cleaning wiper.

**Important!**

- Wear protective gloves when replacing this part.
- When removing the cleaning wiper, be careful of ink dripping.
- Put the used cleaning wiper in a plastic bag and dispose of it according to the local regulations.

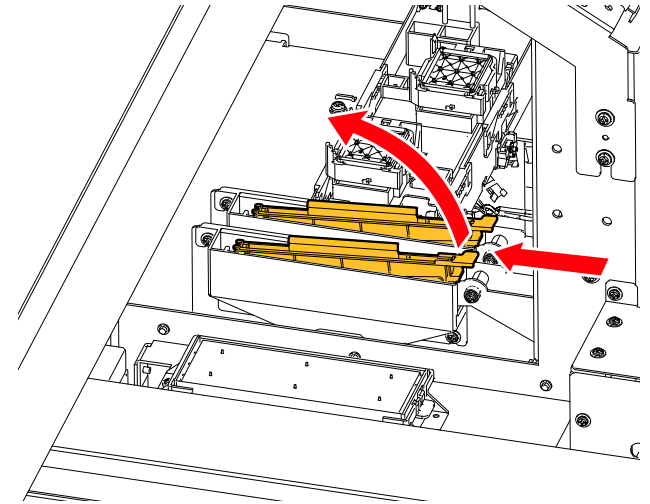

5

Follow these steps to attach a new cleaning wiper.

- Slide the back side of the new cleaning wiper into its slot.
- Press the wiper hook down until it clicks into place.

**Important!**

Do not touch the rubber part of the cleaning wiper with bare hands. If sebum gets on the stick, it will damage the print head.

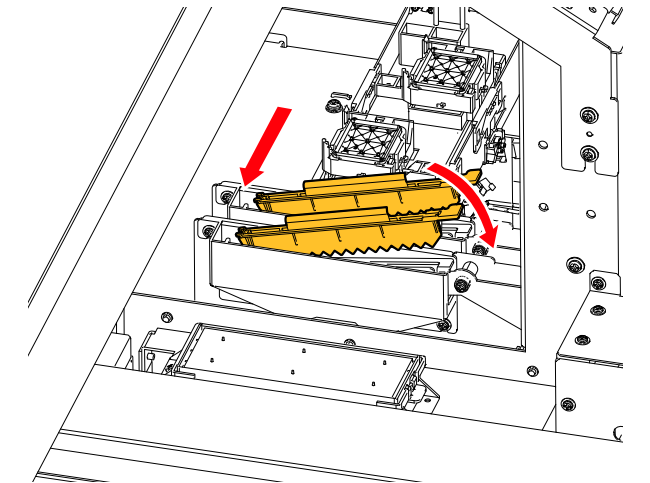

Before Use	
Setup	About Maintenance
Various Settings	Wearing protective equipment
Basic Operations	Agitating ink
Advanced Operations	Checking ink level and replacing ink
<b>Maintenance</b>	<b>Empty the waste ink tank</b>
When problems occur	Daily maintenance at the end of work
Appendix	Printer maintenance
	<b>Replacing consumable parts</b>
	When not using the printer for a long period of time
	Moving or transporting printer

**6** Close the maintenance cover R and the front cover.

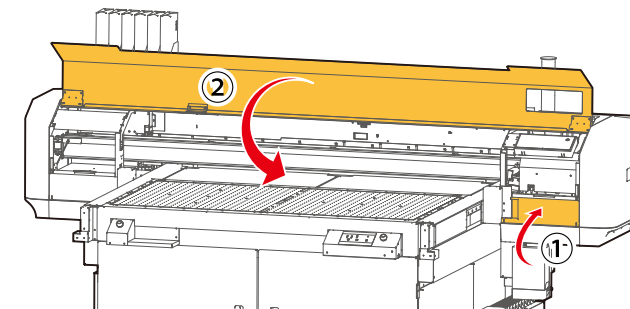

**7** Check that [CR Maintenance End -> Enter] appears on the control panel and tap  Enter key.

- The message [CR Maintenance Start -> Enter] appears.
- The procedure ends here.

Before Use	
Setup	About Maintenance
Various Settings	Wearing protective equipment
Basic Operations	Agitating ink
Advanced Operations	Checking ink level and replacing ink
<b>Maintenance</b>	<b>Empty the waste ink tank</b>
When problems occur	Daily maintenance at the end of work
Appendix	Printer maintenance
	<b>Replacing consumable parts</b>
	When not using the printer for a long period of time
	Moving or transporting printer

## Replace the emitting window glass of the UV-LED lamp

An emitting window glass is a part that protects the UV-LED lamp. Using the printer with dirty or broken glass will cause damage to the lamp or insufficient ink curing. Please replace the glass as needed.

When to replace:

- When the glass has cracks or chips, or ink sticking to the glass cannot be removed.

What you need

- Polyethylene gloves, rubber gloves, protective eye wear, mask
- New glass



**Make sure to read the following sections before this task.**

 ["Handling" P.13](#)

 ["Ink and waste fluid" P.15](#)



### CAUTION



The UV-LED lamp may get hot after printing.

Allow the lamp to cool down for 10 minutes after printing and then start replacement.

## Replacement procedure

1

Wear protective equipment.

 ["Wearing protective equipment" P.171](#)

2

Put the printer in CR maintenance state.

 ["1.Put the printer in CR maintenance state" P.219](#)

Before Use

Setup

Various Settings

Basic Operations

Advanced Operations

Maintenance

When problems occur

Appendix

About Maintenance

Wearing protective equipment

Agitating ink

Checking ink level and replacing ink

Empty the waste ink tank

Daily maintenance at the end of work

Printer maintenance

Replacing consumable parts

When not using the printer for a long period of time

Moving or transporting printer

3

Open the front cover and the maintenance cover L.

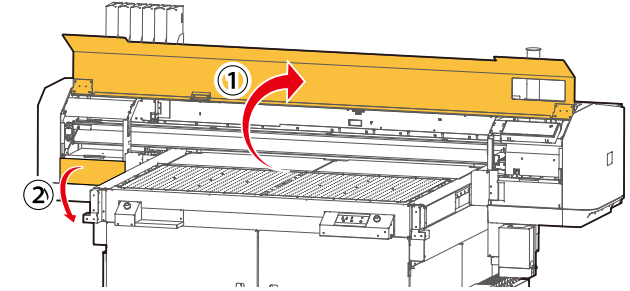

4

Check the glass and replace it if there is any cracks or chips.

- Slide up the left side of the exhaust fan cover. The right side screw serves as a fulcrum.
- Slide the glass attached on the bottom of the lamp towards the front to remove it.
- Check for cracks, chips, or ink on the glass
- Attach a new glass to the UV-LED lamp.
- Firmly slide it into the end and then put the exhaust fan cover back in place.

**Important!**

Make sure that the emitting window glass is attached to the lamp and the exhaust fan cover is put back in place. Using your printer without them will cause damage to the lamp.

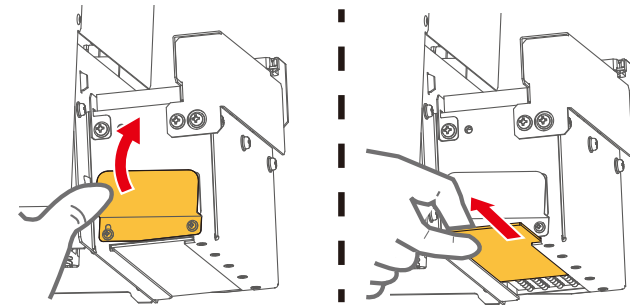

Before Use	
Setup	About Maintenance
Various Settings	Wearing protective equipment
Basic Operations	Agitating ink
Advanced Operations	Checking ink level and replacing ink
<b>Maintenance</b>	Empty the waste ink tank
When problems occur	Daily maintenance at the end of work
Appendix	Printer maintenance
	<b>Replacing consumable parts</b>
	When not using the printer for a long period of time
	Moving or transporting printer

**5** Close the maintenance cover L and the front cover.

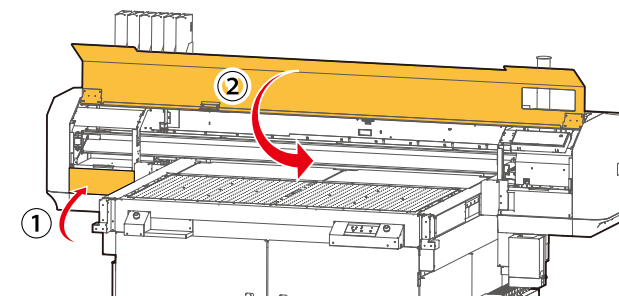

**6** Check that [CR Maintenance End -> Enter] appears on the control panel and tap  Enter key.

- The message [CR Maintenance Start -> Enter] appears.
- The procedure ends here.

Before Use

Setup

Various Settings

Basic Operations

Advanced Operations

Maintenance

When problems occur

Appendix

About Maintenance

Wearing protective equipment

Agitating ink

Checking ink level and replacing ink

Empty the waste ink tank

Daily maintenance at the end of work

Printer maintenance

Replacing consumable parts

When not using the printer for a long period of time

Moving or transporting printer

## Replace the filter of UV-LED lamp

The UV-LED lamp filter protects the lamp from ink mist. Using a dirty filter will cause damage to the lamp.

Make sure you replace it regularly.

When to replace:

- Approximately once a month or when the filter gets dirty by dust or ink.(It depends on usage. Please check regularly.)

What you need

- Polyethylene gloves, rubber gloves, protective eye wear, mask
- New filter



**Make sure to read the following sections before this task.**

☞ "Handling" P.13

☞ "Ink and waste fluid" P.15

## Replacement procedure

1

Wear protective equipment.

☞ "Wearing protective equipment" P.171

2

Put the printer in CR maintenance state.

☞ "1.Put the printer in CR maintenance state" P.219

3

Open the front cover and the maintenance cover L.

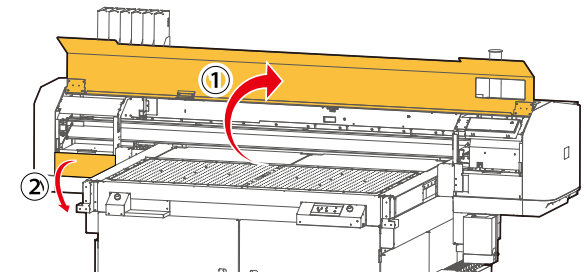

Before Use

Setup

Various Settings

Basic Operations

Advanced Operations

**Maintenance**

When problems occur

Appendix

About Maintenance

Wearing protective equipment

Agitating ink

Checking ink level and replacing ink

Empty the waste ink tank

Daily maintenance at the end of work

Printer maintenance

**Replacing consumable parts**

When not using the printer for a long period of time

Moving or transporting printer

4

While supporting the UV-LED lamp with one hand, remove the filter from the lamp.

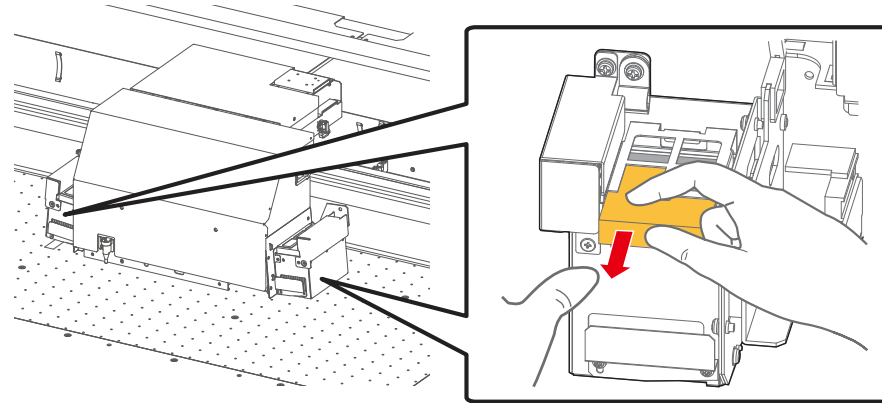

5

Replace with a new filter.

- Firmly insert it into the filter slot.

6

Close the maintenance cover L and the front cover.

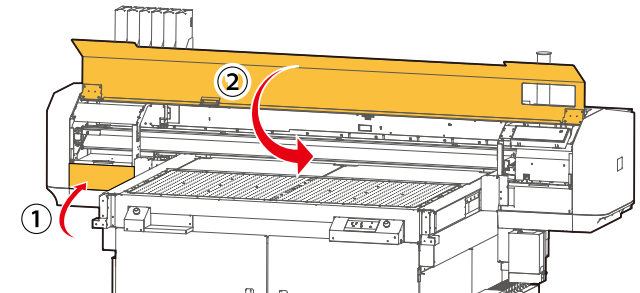

7

Check that [CR Maintenance End -> Enter] appears on the control panel and tap  Enter key.

- The message [CR Maintenance Start -> Enter] appears.
- The procedure ends here.

Before Use	
Setup	About Maintenance
Various Settings	Wearing protective equipment
Basic Operations	Agitating ink
Advanced Operations	Checking ink level and replacing ink
<b>Maintenance</b>	Empty the waste ink tank
When problems occur	Daily maintenance at the end of work
Appendix	Printer maintenance
	<b>Replacing consumable parts</b>
	When not using the printer for a long period of time
	Moving or transporting printer

## Replacing and cleaning the exhaust fan filter

Exhaust fan filters collect ink mist generated inside the printer. You must replace it regularly according to the replacement cycle. Using your printer without replacing this filter will affect printer performance or print quality.

Replacing and cleaning period:

- When the area on the filter which is normally hidden behind the filter frame is also contaminated with ink (Since it differs depending on usage frequency, please check periodically.)

Preparation:

- Polyethylene gloves, rubber gloves, protective eye wear, mask
- Replacement exhaust fan filter
- Paper towel or Soft cloth
- Ethanol (commercially available item: Use one with a concentration of 50% or higher.)

**!** Make sure to read the following sections before this task.

 "Handling" P.13

 "Ink and waste fluid" P.15

**1** Wear protective equipment.

 "Wearing protective equipment" P.171

**2** Tap the  key while media is removed.

- The gantry moves to the front of the printer.
- [Print Ready H:XXX.Xmm Type1] appears.

Before Use

Setup

Various Settings

Basic Operations

Advanced Operations

Maintenance

When problems occur

Appendix

About Maintenance

Wearing protective equipment

Agitating ink

Checking ink level and replacing ink

Empty the waste ink tank

Daily maintenance at the end of work

Printer maintenance

Replacing consumable parts

When not using the printer for a long period of time

Moving or transporting printer

3

Remove the exhaust fan filter from the exhaust fan.

**Important!**

When removing the exhaust fan filter, be cautious of ink drops.

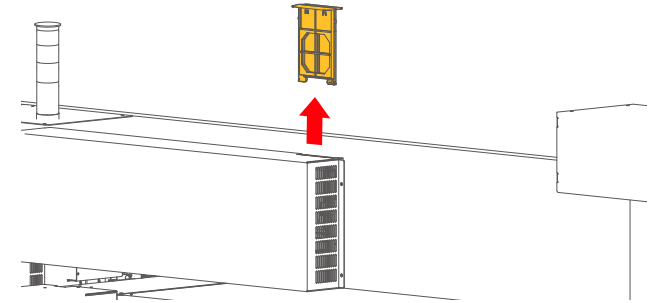

4

Open the cover on the filter.

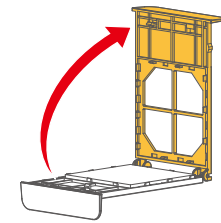

5

Check the filter to see if it needs to be changed.

- If the area on the filter which is normally hidden behind the frame of the fan filter is contaminated with ink, replace it with new one.

After replacement

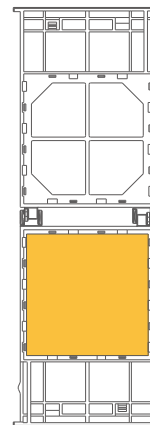

Still good to use

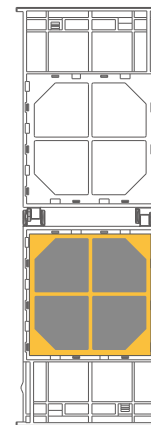

Must replace now

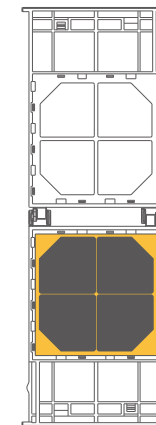

If the filter looks dirty as shown on the left, you must replace with new one.

Before Use

Setup

Various Settings

Basic Operations

Advanced Operations

Maintenance

When problems occur

Appendix

About Maintenance

Wearing protective equipment

Agitating ink

Checking ink level and replacing ink

Empty the waste ink tank

Daily maintenance at the end of work

Printer maintenance

Replacing consumable parts

When not using the printer for a long period of time

Moving or transporting printer

6

If needed, replace with a new filter.

- Remove the filter from the exhaust fan filter cover.

**Important!**

- Wear the rubber gloves over the polyethylene gloves while replacing. Polyethylene gloves is included with the replacement exhaust fan filter.
- When removing the filter, be cautious of ink drops.
- Put the used filter in a plastic bag and dispose of it according to the local regulations.

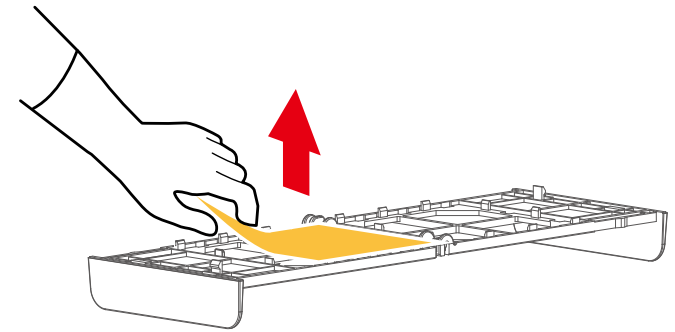

7

Using a soft cloth or a paper towel dampened with little ethanol, clean the cover to remove dirt.

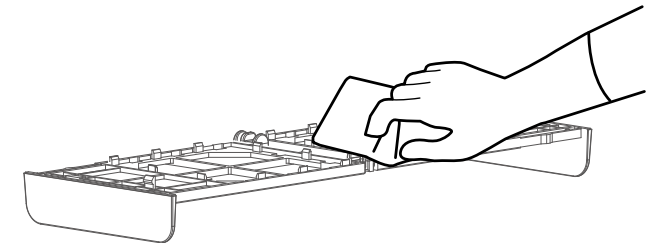

8

Attach a new filter to the cover.

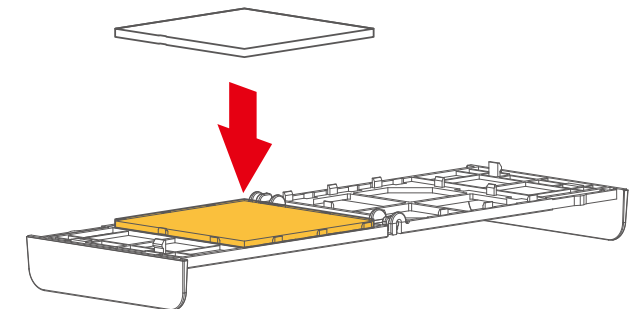

Before Use

Setup

Various Settings

Basic Operations

Advanced Operations

Maintenance

When problems occur

Appendix

About Maintenance

Wearing protective equipment

Agitating ink

Checking ink level and replacing ink

Empty the waste ink tank

Daily maintenance at the end of work

Printer maintenance

Replacing consumable parts

When not using the printer for a long period of time

Moving or transporting printer

9

Close the cover of the exhaust fan filter.

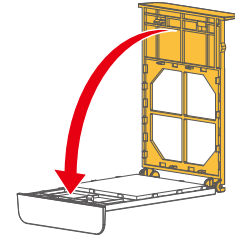

10

After replacing a filter, open the front cover, then clean the inside of the exhaust fan.

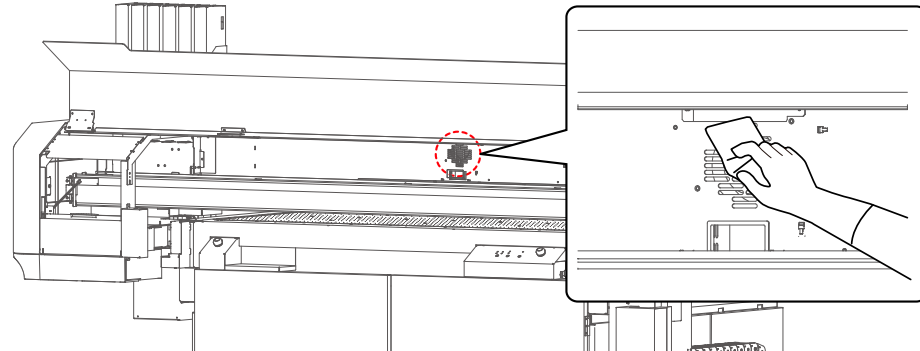

11

Close the front cover, then attach the filter to the exhaust fan.

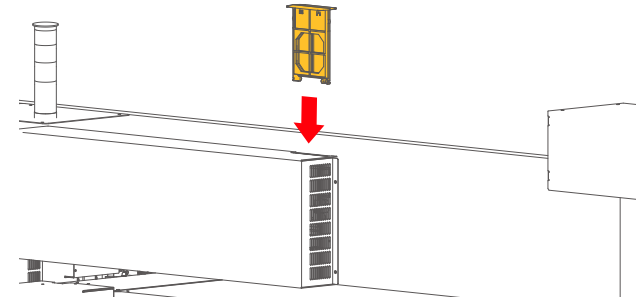

12

Tap  key.

- The gantry goes back to the home position.
- [Set media. then Tap[  ] key.] appear.

Before Use	
Setup	About Maintenance
Various Settings	Wearing protective equipment
Basic Operations	Agitating ink
Advanced Operations	Checking ink level and replacing ink
<b>Maintenance</b>	Empty the waste ink tank
When problems occur	Daily maintenance at the end of work
Appendix	Printer maintenance
	Replacing consumable parts
	<b>When not using the printer for a long period of time</b>
	Moving or transporting printer

# When not using the printer for a long period of time

If you are not using the printer for a long period of time (maximum one month), follow these steps to power off the printer.

**!** Make sure to read the following sections before this task.

☞ "Handling" P.13

☞ "Ink and waste fluid" P.15

## 1. Perform a daily maintenance

- 1 Prepare the items required for daily maintenance.  
☞ "Preparations for daily maintenance" P.195
- 2 Put the printer in daily maintenance state.  
☞ "1.Put the printer in daily maintenance state." P.209
- 3 Clean each part of the printer.  
☞ "2.Clean each part of the printer" P.210
- 4 Once the maintenance is complete, close the front cover and maintenance cover and tap  Enter key.  
☞ "5. End the maintenance" P.202

Before Use

Setup

Various Settings

Basic Operations

Advanced Operations

Maintenance

When problems occur

Appendix

About Maintenance

Wearing protective equipment

Agitating ink

Checking ink level and replacing ink

Empty the waste ink tank

Daily maintenance at the end of work

Printer maintenance

Replacing consumable parts





When not using the printer for a long period of time

Moving or transporting printer

## 2. Flush ink out of printer

1

Go to the "Ink Discharge" menu.



- Tap  Home key → [Menu1 Setup] appears.
- Tap  key several times to select [Menu 3 Maintenance].
- Tap  key → [Maintenance1 Cleaning] appears.
- Tap  /  key to select [Maintenance4 Ink Discharge].

2

Tap  key and when [Ink Discharge Start -> Enter] appears, tap  Enter key.

3

If the message [Empty Waste Ink Tank then Tap Enter] appears, drain waste fluids into a container.

- Tap  Enter key.  
 ["Empty the waste ink tank" P.189](#)

4

When [Remove Cartridges] appears, remove all the high-capacity ink pack adapters from the ink slots.

- When [Discharging \*\*%] appears, it begins flushing ink out of the printer.
- When [No Cart xxxxxx] appears, drain waste fluids into a container to empty the waste ink tank.  
 ["Empty the waste ink tank" P.189](#)
- Remove the ink bag from the high-capacity ink pack adapter and put it in the original packaging box. Then store it and the high-capacity ink pack adapter in the light-blocking cabinet.

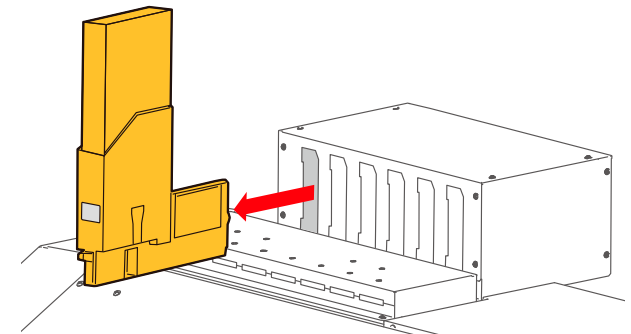

5

The procedure ends here.

Before Use	
Setup	About Maintenance
Various Settings	Wearing protective equipment
Basic Operations	Agitating ink
Advanced Operations	Checking ink level and replacing ink
<b>Maintenance</b>	Empty the waste ink tank
When problems occur	Daily maintenance at the end of work
Appendix	Printer maintenance
	Replacing consumable parts
	<b>When not using the printer for a long period of time</b>
	Moving or transporting printer

### 3. Skip daily maintenance and power off the printer

- 1 Press and hold the Power button for more than two seconds.
  - The message [Daily Maintenance Start -> Enter] appears.

- 2 Tap  Cancel key.
  - This will skip a daily maintenance.

#### Important!

Make sure to perform a daily maintenance before powering off the printer. Powering off without daily maintenance could cause nozzle clogging.

- 3 The printer begins powering off.

Before Use	
Setup	About Maintenance
Various Settings	Wearing protective equipment
Basic Operations	Agitating ink
Advanced Operations	Checking ink level and replacing ink
<b>Maintenance</b>	<b>Empty the waste ink tank</b>
When problems occur	Daily maintenance at the end of work
Appendix	Printer maintenance
	Replacing consumable parts
	<b>When not using the printer for a long period of time</b>
	Moving or transporting printer

## Initial ink charging after flushing ink out of the printer

- 1** Press and hold the Power button for more than two seconds.

  - The small LED above the button and all the keys light up.
  - Printer initialization begins.
- 2** When [Ink Charge Start -> Enter] appears, check that the waste ink tank is empty or only a small amount of fluids is collected. Then tap  Enter key.
- 3** When the message [Empty Waste Ink Tank then Tap Enter] appears, drain waste fluid into a container.

 ["Empty the waste ink tank" P.189](#)

  - After emptying the tank, tap  Enter key.
- 4** When [Insert Ink Cartridges] appears, agitate the ink in each ink bag and insert it in the high-capacity ink pack adapter. Then insert it into each ink slot.

 ["3. Initial Ink Charging" P.67](#)

** Important!**

Be sure to use new ink bags. If a used ink bag does not have enough ink, it will run out of ink during initial ink charging and will consume more ink.
- 5** Once ink bags are installed, follow the instructions on ["4. The procedure after installing ink bag" P.71](#) to perform initial ink charging.

Before Use	
Setup	About Maintenance
Various Settings	Wearing protective equipment
Basic Operations	Agitating ink
Advanced Operations	Checking ink level and replacing ink
<b>Maintenance</b>	Empty the waste ink tank
When problems occur	Daily maintenance at the end of work
Appendix	Printer maintenance
	Replacing consumable parts
	When not using the printer for a long period of time
	<b>Moving or transporting printer</b>

# Moving or transporting printer

## Important!

This product must be repacked in the original packaging and packaging materials as you purchased. Otherwise it will cause damage or failure.

When moving or transporting your printer, make sure to consult your local MUTOH dealer.

# When problems occur

**Messages and Error Messages** 242

**Troubleshooting** 251

Before Use

Setup

Various Settings

Basic Operations

Advanced Operations

Maintenance

When problems occur

Appendix

Messages and Error Messages

Troubleshooting



# Messages and Error Messages

This section describes messages displayed during normal printer operation or when errors occur, and solutions to the messages.

## Status messages

This section describes messages displayed during printer normal operation.

When the printer is working correctly, the following status message is displayed on the control panel.

Display	Description
Activation required	Printer has not been activated yet. Follow the Startup Guide to activate your printer.  <a href="#">"Activate the printer" P.60</a>
F / W update required >> Controller F / W <<	MUTOH Status Monitor (MSM) is required to update the controller firmware. For the method of updating, see the section "Firmware Update" in the MUTOH Status Monitor operation manual.
Print Ready	Ready-to-print state (Media is loaded in the printer)
Set media, then Tap [ ^ ] key.	Ready-to-print state (Media is not loaded in the printer)
Receiving	Job is being received.
Converting	Job is being converted.
Printing	Job is being printed.
Pausing Print Cancel Print -> Enter	Printing is being paused. <ul style="list-style-type: none"><li>• To resume printing, tap  Cancel key.</li><li>• To cancel printing, tap  Enter key. (you cannot resume printing)</li></ul>
Power Off	The printer is being powered off. Please wait.
S/C Reading	The smartchip is being read.

Before Use

Setup

Various Settings

Basic Operations

Advanced Operations







Maintenance

When problems occur

Appendix

Messages and Error Messages

Troubleshooting

Ink Circulation	** %	Ink circulation is being performed in the printer.
Ink Charge Start -> Enter		To perform ink charging, tap  Enter key.
Insert CleaningCart.		Install the cleaning cartridges to flush the print head.
Washing Head	** %	The print head is being flushed. Please wait.
Remove Cart.		Remove ink bags or cleaning cartridges.
Insert InkCartridges		Install ink bags to perform ink charging.
Ink Refill	** %	Ink is being filled. Please wait.
During discharge	** %	Ink is being discharged. Please wait.
Perform Daily Maint.		The scheduled time has passed since the last daily maintenance. Perform a daily maintenance.  <a href="#">"Cleaning each part of the printer" P.209</a>
Empty Waste Ink Tank then Tap Enter		Drain waste fluids into a container to empty the waste ink tank, and then tap  Enter key.  <a href="#">"Empty the waste ink tank" P.189</a>
[56] Remove Cart.		This message appears during initial cleaning before initial ink charging. Remove the cleaning cartridges from the ink slots 5 and 6.  <a href="#">"Perform initial cleaning to initial ink charging" P.62</a>
[56] Insert Cart.		This message appears during initial cleaning before initial ink charging. Insert the cleaning cartridges into the ink slots 5 and 6.  <a href="#">"Perform initial cleaning to initial ink charging" P.62</a>
Dump data available		When Header Dump is set to [ON], this message appears notifying that there is a dump data to be printed.  <a href="#">"Header Dump" P.103</a>

Before Use

Setup

Various Settings

Basic Operations

Advanced Operations

Maintenance

When problems occur





Appendix

Messages and Error Messages

Troubleshooting

## Error message and possible solutions

This section describes the error messages that can be displayed when an error occurs and the solutions to the errors.

Display	Description
Cover Open	Any or all of covers (front cover, maintenance cover R, maintenance cover L) are open. Close it.
[*****] Ink End	Ink bag has run out of ink (The printer will stop operation). Remove the ink cartridge and replace with a new ink bag. Invert the ink cartridge as instructed to agitate ink and then insert it into the ink slot. Replace with a new smartchip card. (This message appears when Remain Ink is set to [Off])  <a href="#">"Checking ink level and replacing ink" P.181</a>
[*****] No Cart	Ink cartridge is not installed (Printer stops operation) Insert the ink cartridge into the ink slot.
Ink End 	Ink is out (in the example on the left, slot 2 and slot 3) (The printer will stop operation). Remove the ink cartridge and replace with a new ink bag. Invert the ink cartridge as instructed to agitate ink and then insert it into the ink slot. (This message appears when Remain Ink is set to [On])  <a href="#">"Checking ink level and replacing ink" P.181</a>
No Cart. 	An ink cartridge is not installed (in the example on the left, slot 5 and slot 6) Insert an ink cartridge into the ink slot. (This message appears when Remain Ink is set to [On])
[****] No S/C Card	A smartchip card is not inserted. (The printer will stop operation) Insert a smartchip card into the card slot.

Before Use

Setup

Various Settings

Basic Operations

Advanced Operations





Maintenance

When problems occur

Appendix

Messages and Error Messages

Troubleshooting

Display	Description
[*****] Discharged	The printer is not filled with ink. Perform initial ink charging.  <b>"Initial ink charging after flushing ink out of the printer" P.239</b> When you move the printer or when you are not using the printer for a long period, turn the printer off.  <b>"When not using the printer for a long period of time" P.236</b>
Empty Waste Ink Tank then Tap Enter	This message appears periodically. Drain waste fluids into a container to empty the waste ink tank.  <b>"Empty the waste ink tank" P.189</b>
Full WasteInkTank	The waste ink tank is full. (The printer will stop operation) Immediately drain the waste fluids into a container to empty the tank.  <b>"Empty the waste ink tank" P.189</b>
[****] S/C ReadErr	Failed to read the chip. Insert the smartchip card again.
[****] S/C Col. Err	The smartchip card is inserted into the incorrect slot. Insert it into the correct slot. Also, check that the ink cartridge is inserted into the correct ink slot.
[****] S/C CodeErr	The smartchip card inserted is not supported by this printer. Please contact your local MUTOH dealer.
[****] Broken Chip	The smartchip card is damaged. Replace with a new smartchip card.
[****] Check Ink	Ink cartridge is not inserted correctly. Insert the cartridge straight into the ink slot.
[****] S/C Recog. E	The smartchip card may require "smartchip recovery". Insert the smartchip card into the card slot again. If the chip still cannot be read correctly, insert a new smartchip card. When the message [[****] Check Color OK ->Enter] appears after reinsertion, follow the instructions in the panel display to operate.

Before Use

Setup

Various Settings

Basic Operations

Advanced Operations





Maintenance

When problems occur

Appendix

Messages and Error Messages

Troubleshooting

Display	Description
[***] Check Color OK ->Enter	The smartchip card may required "smartchip recovery". Check to see if the correct smartchip card is inserted. • If the wrong card is installed, insert the correct one into the slot. • If the correct card is inserted, tap  Enter key so that the printer will perform the recovery processing. Printing can be continued.
[****] Chg. S/C Card	The ink bag that smartchip recovery was performed has run out of ink. Replace with a new S/C card.
Obstacle Detected Tap [ √ ] key.	The media height detector detected obstacle. Tap  key and load media on the table again.  <a href="#">"Load media" P.72</a>
[****] Ink Low Type 1 	The ink became low. (The printer continues operations) Prepare a new ink bag for replacement. (This message appears when Remain Ink is set to [Off])
Ink Low Type 1	The ink became low (in the example on the left, slot 5 and slot 6) (The printer continues operations) Prepare a new ink bag for replacement. (This message appears when Remain Ink is set to [On])
KMCYW Agitate Ink	The scheduled time has passed since the last ink agitation. Agitate the inks in the Black (K), Magenta (M), Cyan (C), Yellow (Y) and White(W) ink bags.
Unable to Enter to Sleep Mode	An error has occurred while in preparation process of sleep mode (daily maintenance). Tap  Enter key and follow the instructions displayed to operate the printer.
[****] Change Plug	The high-capacity ink pack adapter was used for a certain number of times. Replace with a new plug in the adapter.
Load media then switch to [Print]	The vacuum table is in [Media Set] state. (Operator is working on the vacuum table) Once you finish loading media and working on the table, change the Print/Media Set switch on the vacuum control panel to [Print].

Before Use

Setup

Various Settings

Basic Operations

Advanced Operations





Maintenance

When problems occur

Appendix

Messages and Error Messages





Troubleshooting

Display	Description
Switch to [Print]	The vacuum table is in [Media Set] state. (Operator is working on the vacuum table) Once you finish working on the table, change the Print / Media Set switch on the vacuum control panel to [Print].
No Media	Media is not loaded in the printer. Load media and then perform this operation again. (Tap  key to change the status to [Print Ready])
Media height Error Tap [ √ ] key.	Media height exceeds the limit. Tap  key and load media again.  <a href="#">"Load media" P.72</a>
Outside Print Area	The size of media is not long enough to print.
Drop Sensor Failed Auto NozzleCheck Off	The drop sensor is broken. Printing is still possible, but you cannot use the automatic nozzle check function. Please contact your local MUTOH dealer.
Auto Nozzle Check Nuzzle Clog Present	The printer run an auto cleaning cycle to recover blocked nozzles that an auto nozzle check detected, but the nozzles are still clogged. Manually run a nozzle check and cleaning cycles. <a href="#">"Run a nozzle check and cleaning" P.78</a>
Emergency Stop Reboot Printer	Emergency stop button has been pushed. To release the button, see <a href="#">"Stop the printer for emergency" P.147</a>
Ink Not Expired? OK -> Enter	Check the "Use Before" date on the cartridge (ink bag) label. Once you have finished checking the expiration date or replacing the ink cartridge (ink bag), tap  Enter key.
[****] Ink Expired	This message appears when the ink cartridge (ink bag) has expired. Replace with a non-expired one.

 **Note**

- The number in [\*\*\*\*\*] identified the slot number where the error occurred.
- If "Ink End" and "No Cartridge" errors occurred at the same time, "No Cartridge" will be displayed in priority to the "Ink End" error.

Before Use	
Setup	
Various Settings	
Basic Operations	
Advanced Operations	
Maintenance	
<b>When problems occur</b>	<b>Messages and Error Messages</b>
	Troubleshooting
Appendix	

Display	Description
Temperature too low	<ul style="list-style-type: none"> <li>Printer's temperature is too low. Tap  key to remove media and then adjust room temperature. Wait until the warning message is no longer displayed.</li> <li> <a href="#">"Specifications" P.261</a></li> </ul>
Temperature too high	<ul style="list-style-type: none"> <li>Printer's temperature is too high. Tap  key to remove media and then adjust room temperature. Wait until the warning message is no longer displayed.</li> <li> <a href="#">"Specifications" P.261</a></li> </ul>

Before Use

Setup

Various Settings

Basic Operations

Advanced Operations

Maintenance

When problems occur

Appendix

Messages and Error Messages

Troubleshooting

## Smartchip recovery

When the following message is prompted on the control panel, a smartchip error such as broken chip may have occurred in the smartchip card.

Check that the correct smartchip card is inserted and then perform smartchip recovery. This will allow you to continue to print.

To perform smartchip recovery, do one of the followings according to the message appeared.

Display	Description
[****] S/C Recog. E	The smartchip card that needs a smartchip recovery may have been installed. Remove the smartchip card and insert it again. If the printer is still unable to read it, insert a new smartchip card and a new ink bag. <ul style="list-style-type: none"><li>If a message “[****] Check Color OK -&gt;Enter” appears after the smartchip card is reinserted, follow the message “[****] Check Color OK -&gt;Enter” to operate.</li></ul>
[****] Check Color OK ->Enter	The smartchip card that needs a smartchip recovery may have been installed. Check that the ink color of the smartchip card inserted is correct. <ul style="list-style-type: none"><li>In case of wrong color insertion, insert a correct smartchip card.</li><li>If color is correct, tap  Enter key. The printer will perform smartchip recovery and will continue to print.</li></ul>

### Note

• During smartchip recovery execution, the ink being recovered blinks in the ink status menu or the ink indicator.

 [“Ink level indicator on the printer control panel” P.36](#) [“Printer Status menu” P.129](#)

Before Use

Setup

Various Settings

Basic Operations

Advanced Operations

Maintenance

When problems occur

Appendix

Messages and Error Messages

Troubleshooting

## Error requiring restart

An error requiring restart is displayed if a fatal operational failure such as the following occurs.

- When an error that prevents the printer from driving occurred.
- When the electrical circuit (PCB, motor, sensor, etc.) of the printer is broken.
- When a failure in the printer control program occurred.

If this error occurs, the printer will stop operation after

1. the power of drive source was automatically shut down.
2. all the LED on the printer control panel blink, and the buzzer beeps repeatedly.
3. the error message is displayed on the printer control panel and MUTOH Status Monitor.

Pressing any key on the control panel will stop the beeps. For this kind of error, operation will return to normal after removing the cause of the error and restarting the printer. If the same error occurs again, please contact your local MUTOH dealer. Be sure to tell us the code number of the error message when you contact us.

Message	Solutions
Emergency Mode : E***	A trouble that the error cannot be released has occurred. 1. Check that the part you replaced has been installed correctly. 2. Press Power button to turn the printer off. Wait for a while and press Power button again to restart the printer.
Emergency Mode : AC	The printer instantaneously shut down while starting. 1. Press Power button to turn the printer off. Wait for a while and press Power button again to restart the printer.
Emergency Mode : CPU	CPU error has occurred. 1. Press Power button to turn the printer off. Wait for a while and press Power button again to restart the printer.

### Note

"\*\*\*" in the error message is the error code that identifies what type of error occurred.

Before Use

Setup

Various Settings

Basic Operations

Advanced Operations

Maintenance

When problems occur

Appendix

Messages and Error Messages

Troubleshooting

# Troubleshooting



This section describes printer troubles that an error message is not prompted, and possible cause and solutions.

## Note

- The printer status and error information can be checked from the Printer Status tab > Status Information in MSM. If your printer is not working correctly, check this Status Information first.
- Make sure to use the latest version of MSM. To check the latest available version, go to Help > Version > Check for updates in MSM. If old version is installed in your computer, download the latest version from MUTOH Club.

 [MUTOH Status Monitor Operation Manual](#)

## Installation/ initial setup-related trouble

Description	Possible cause and Remedy
Cannot perform initial ink charging.	Check that <ul style="list-style-type: none"><li>• the front cover and all the maintenance covers are closed.</li><li>• ink cartridges are inserted all the way into each slots.</li></ul>
Ink does not come out after ink charging.	Check that the ink bag is not too cold. <ul style="list-style-type: none"><li>• Rest the ink bag at room temperature for at least three hours, and perform "Head Cleaning" several times.</li></ul> <p> <a href="#">"Head cleaning" P.204</a></p> <ul style="list-style-type: none"><li>• If the power was turned OFF during initial ink charging, turn the printer on again and perform initial ink charging again.</li></ul>
Nozzle clogging occurs after initial ink charging.	Did you perform head cleaning? <ul style="list-style-type: none"><li>• Perform cleaning, then, check the print result.</li></ul> <p> <a href="#">"Head cleaning" P.204</a></p> <ul style="list-style-type: none"><li>• If there is no improvement even after performing cleaning, rest the printer for at least one hour, perform a head cleaning or "Little Charge" again and then run a nozzle check print.</li><li>• If the problem still persists, please contact your local MUTOH dealer.</li></ul>

Before Use

Setup

Various Settings

Basic Operations

Advanced Operations

Maintenance

When problems occur

Appendix

Messages and Error Messages

Troubleshooting

MSM or RIP software cannot connect to the printer

Check that the Ethernet cable is connected securely to the Ethernet port.

Check that the network settings are configured correctly.

Check that the printer's network settings match the computer's settings.

 ["Configure the initial settings" P.57](#)

## Printer operation-related trouble

Description	Possible cause and Remedy
Printer does not work at all after powered on or even after media is loaded.	Check that the power cord is plugged into the wall outlet.
	Check that the voltage of the wall outlet is within the rated voltage range.
	Check that the front cover and all the maintenance covers are closed.
	<ul style="list-style-type: none"><li>Go to the Printer Status tab in MSM and check if any error message is displayed in the Status Information.</li><li>Check that you use the printer within the recommended environmental conditions.</li></ul>
	 <a href="#">Startup Guide "Check before installation" P.5</a>

Before Use

Setup

Various Settings

Basic Operations

Advanced Operations

Maintenance





When problems occur

Appendix

Messages and Error Messages

Troubleshooting

## Media-related trouble

Description	Possible cause and Remedy
Print head strikes media while printing	Check that media is loaded on the table correctly.  <a href="#">"Supported media" P.43</a> , <a href="#">"Load media" P.72</a>
	Check that the media does not have any wrinkles. <ul style="list-style-type: none"><li>• Smooth out the media to sit flat on the table.</li></ul>
	Check that the media does not have warps, folds or curls. <ul style="list-style-type: none"><li>• See <a href="#">"Media handling cautions" P.43</a></li><li>• If media does not sit flat on the table, secure it on the table using a thin tape to avoid any warps.</li></ul>
	Optimize the suction volume. <ul style="list-style-type: none"><li>• If media warps, setting the suction volume higher will reduce the chance of warps.</li></ul>
	 <a href="#">"How to operate vacuum control panel" P.39</a> , <a href="#">"Load media" P.72</a>
	Check that the media does not have curls while printing. <ul style="list-style-type: none"><li>• It can curl by UV light or ink curing. Use heat-resistant media or use a jig to prevent curls.</li></ul>  <a href="#">"Media handling cautions" P.43</a>
The area in front of the guide line on the front side of the table is outside the sensing area of the media height detector. <ul style="list-style-type: none"><li>• Do not place any objects (including jig) which are higher than the media placed on the table here. This will cause the print head to strike it.</li></ul>  <a href="#">"Printable area" P.134</a>	

Before Use

Setup

Various Settings

Basic Operations

Advanced Operations

Maintenance

When problems occur

Appendix

Messages and Error Messages

Troubleshooting

Printer cannot detect media correctly when loaded

For a transparent material that light can pass through, the media height detector may not detect it.

- Tape the masking tape on the sides of media so that the detector can detect it correctly.
- Change the Media Setting Height to [Manual].



 ["Height" P.101](#)

If you are using a textured media or uneven media, the sensor detects the highest position on the media as media surface. The printer may not be able to print properly.

 ["Media handling cautions" P.43](#)



For media with uneven or curved bottom surface, the laser light can pass through the gap so that the printer may not be able to adjust the table height properly.

Is an error message "Temperature too low" or "Temperature too high" displayed on the control panel?

- If the product is used in the environment that does not meet "Environmental Requirements", the height of media may be detected higher or lower than the actual height. In such cases, tap  key to remove media and then adjust room temperature. Once you confirm the message is no longer displayed, tap  key again and load media.

Before Use	
Setup	
Various Settings	
Basic Operations	
Advanced Operations	
Maintenance	
<b>When problems occur</b>	Messages and Error Messages
	<b>Troubleshooting</b>
Appendix	





## Printing-related trouble

Description	Possible cause and Remedy
The carriage pauses at the left or the right side of the printer while printing.	<p>Check that your computer meet the following requirements:</p> <ul style="list-style-type: none"> <li>• OS: Windows 11, Windows 10</li> <li>• CPU: Intel (R) Core (TM) i5 or higher</li> <li>• Memory: No less than 8G byte</li> <li>• Network: Use a network port that supports Gigabit Ethernet, and an Ethernet cable that supports Category 6 Gigabit Ethernet or later.</li> </ul> <div style="border: 1px solid green; padding: 5px; margin-top: 10px;"> <p> <b>Note</b></p> <ul style="list-style-type: none"> <li>• The OS support period of software supplied from MUTOH conforms to the Microsoft support lifecycle policies.</li> <li>• Please also check the system requirements of your RIP software if you are using.</li> </ul> </div> <hr/> <p>To connect your printer to your computer, make sure to use a Gigabit Ethernet cable Category 6 or later.</p> <p> <a href="#">"Connecting to a computer" P.47</a></p>







Before Use	
Setup	
Various Settings	
Basic Operations	
Advanced Operations	
Maintenance	
<b>When problems occur</b>	<p>Messages and Error Messages</p> <p><b>Troubleshooting</b></p>
Appendix	

Printer doesn't expectedly print (ink mottle, ink bleed or faint print appears)	Check that media is loaded on the table correctly. ☞ <a href="#">"Load media" P.72</a>
	Check that the ink bags installed on the printer are not expired.
	When "Agitate XX Ink" message appears on the control panel, agitate ink in the ink bag. ☞ <a href="#">"Agitating ink" P.172</a>
	<ul style="list-style-type: none"> <li>Run a nozzle check to see if the nozzles are in good condition. If nozzle clogs, perform head cleaning. ☞ <a href="#">"Run a nozzle check and cleaning" P.78</a></li> <li>Perform a daily maintenance. ☞ <a href="#">"Cleaning each part of the printer" P.209</a></li> <li>If nozzle clogging persists, perform "Little Charge". ☞ <a href="#">"Head cleaning" P.204</a></li> </ul>
	If the Ink Maintenance option is set to [Normal] or [Light], select [Full]. ☞ <a href="#">"Ink Maintenance" P.104</a>
	Perform "Adjust Print" calibration. ☞ <a href="#">""Adjust Print" calibration" P.88</a>
	Perform "PF Adjust" calibration. ☞ <a href="#">"Gantry feed adjustment (PF Adjust)" P.122</a>
Check that the suction volume is appropriate for the media being loaded. <ul style="list-style-type: none"> <li>If you use a thin or soft media and suffer from wrinkles, setting the suction volume lower will help to improve print quality. ☞ <a href="#">"How to operate vacuum control panel" P.39</a> , <a href="#">"Load media" P.72</a></li> </ul>	

Before Use	
Setup	
Various Settings	
Basic Operations	
Advanced Operations	
Maintenance	
<b>When problems occur</b>	<p>Messages and Error Messages</p> <p><b>Troubleshooting</b></p>
Appendix	

Printer doesn't expectedly print (ink mottle, ink bleed or faint print appears)	<p>Is an error message "Temperature too low" or "Temperature too high" displayed on the control panel?</p> <ul style="list-style-type: none"> <li>If the product is used in the environment that does not meet "Environmental Requirements", the height of media may be detected higher or lower than the actual height. In such cases, tap  key to remove media and then adjust room temperature. Once you confirm the message is no longer displayed, tap  key again and load media.</li> </ul>
Printing lines are not straight/are duplicated or patchy.	<p>Is ink cartridge (ink bag) within the validity period?</p> <ul style="list-style-type: none"> <li>Use a non-expired ink cartridge (ink bag).</li> </ul>
Ink is dripping on media or table	<ul style="list-style-type: none"> <li>Check that the cleaning wiper or the parts around the print head are clean. If not, clean these parts. <ul style="list-style-type: none"> <li> <b>"Run a nozzle check and cleaning" P.78</b></li> </ul> </li> <li>Perform a daily maintenance and run a nozzle check. <ul style="list-style-type: none"> <li> <b>"Cleaning each part of the printer" P.209 ;"Run a nozzle check and cleaning" P.78</b></li> </ul> </li> </ul> <hr/> <ul style="list-style-type: none"> <li>Check the condition of the flushing box pad and replace with a new one if needed. <ul style="list-style-type: none"> <li> <b>"Replace the flushing box pad" P.220</b></li> </ul> </li> </ul>
Image was printed in the wrong place / partially printed	<p>Check that the media is loaded on the correct position.</p> <ul style="list-style-type: none"> <li>Check that the Origin setting is correct. Go to the Origin menu and check that the LED pointer shows the correct position.</li> <li>Check that the Media Size settings are correct.</li> </ul>

Before Use	
Setup	
Various Settings	
Basic Operations	
Advanced Operations	
Maintenance	
<b>When problems occur</b>	<p>Messages and Error Messages</p> <p><b>Troubleshooting</b></p>
Appendix	

<p>Printed color is not accurate.</p>	<p>Check that the settings for print job, media and printer are correctly set.</p> <hr/> <p>When "Agitate XX Ink" message appears on the control panel, agitate ink in the ink bag.   <a href="#">"Agitating ink" P.172</a></p> <hr/> <p>Is ink cartridge (ink bag) within the validity period?  <ul style="list-style-type: none"> <li>• Use a non-expired ink cartridge (ink bag).</li> </ul> </p> <hr/> <ul style="list-style-type: none"> <li>• Run a nozzle check to see the nozzles are in good condition. If the nozzle clogs, perform a head cleaning.   <a href="#">"Run a nozzle check and cleaning" P.78</a></li> <li>• Perform a daily maintenance.   <a href="#">"Cleaning each part of the printer" P.209</a></li> <li>• If the nozzle still clogs, perform "Little Charge".   <a href="#">"Head cleaning" P.204</a></li> </ul> <hr/> <p>Is an error message "Temperature too low" or "Temperature too high" displayed on the control panel?  <ul style="list-style-type: none"> <li>• If the product is used in the environment that does not meet "Environmental Requirements", the print head may not fire ink properly. In such cases, tap  key to remove media and then adjust room temperature. Once you confirm the message is no longer displayed, perform a head cleaning.</li> </ul> </p>
<p>Printer doesn't print.</p>	<p>Check that the Ethernet cable is connected securely to the Ethernet port.   <a href="#">"Supported media" P.43</a> , <a href="#">"Load media" P.72</a></p> <hr/> <p>Go to the Printer Status tab in MSM and check that if any error message is displayed in the Status Information.</p>

Before Use

Setup

Various Settings

Basic Operations

Advanced Operations

Maintenance



When problems occur

Appendix

Messages and Error Messages

Troubleshooting

Performed head cleaning, but the nozzle still clogs.

- Check that the cleaning wiper or the parts around the print head are clean. If not, clean these parts.  
 ["Run a nozzle check and cleaning" P.78](#)
- Perform a daily maintenance and run a nozzle check.  
 ["Cleaning each part of the printer" P.209](#) , ["Run a nozzle check and cleaning" P.78](#)
- If the problem persists, please contact your local MUTOH dealer.

 **Important !**

Do not use light reflective media. It may have a chance to cure the ink on the print head.

# Appendix

**Specifications** 261

**Optional accessories / Consumable supplies** 263

**Revision history** 264

Before Use

Setup

Various Settings

Basic Operations

Advanced Operations

Maintenance

When problems occur

Appendix

Specifications

Optional accessories / Consumable supplies

Revision history

# Specifications

<b>Model name</b>	XPJ-1462UF
<b>Printing method</b>	On demand piezo method
<b>Driving method</b>	Firmware servo/ DC motor drive
<b>Gantry feeding method</b>	Ballscrew feeding
<b>Media hold-down system</b>	Vacuum fan
<b>Ink curing system</b>	UV-LED lamp
<b>Media size</b>	Maximum width 1420 mm
	Maximum length 700 mm
	Maximum thickness 150 mm
	Weight up to 50 kg /m <sup>2</sup> (including jig)
<b>Maximum printable width</b>	1420 mm
<b>Maximum printable length</b>	700 mm
<b>Print head height adjustment</b>	Automatic adjustment using media height detector (can be adjusted manually)
<b>Interface</b>	Gb-Ethernet (1000BASE-T)
<b>Ink</b>	Color 6 colors (Black/ Cyan/ Magenta/ Yellow/ White/ Varnish)
	Type UH21 or US61
	Ink volume 800 ml ink bag (UH21 white: 500 ml bag)
<b>Waste ink tank</b>	2,000 ml tank attached to the printer, Empty the tank when needed
<b>Environmental requirements</b>	Operating condition: Temperature: 20 °C to 32 °C , Humidity: 40%to 60% non condensing
	Printing condition: Temperature: 22 °C to 30 °C , Humidity: 40%to 60% non condensing
	Fluctuation: Temperature: no more than 2 °C per hour Humidity: no more than 5% per hour
<b>Printer storage condition</b>	Storage without ink filled: within 6 months
	Temperature: -20 °C to 60 °C , Humidity 20% to 80% non condensing
	Storage with ink filled: within 30 days*1 Temperature: 5 °C to 30 °C , Humidity: 20% to 80% non condensing *1 Printer must be put into sleep mode. Make sure to check ink level.

Before Use

Setup

Various Settings

Basic Operations

Advanced Operations

Maintenance

When problems occur

Appendix

Specifications

Optional accessories / Consumable supplies

Revision history

**Ink storage condition**

·UH21 ink  
Black, Cyan, Magenta, Yellow,  
Varnish (800 ml)  
White (500 ml)  
Temperature: -10 °C to 50 °C (Storage up to one month maximum when stored between 40 °C to 50 °C )  
Humidity: 5% to 85% non condensing

·US61 ink  
Black, Cyan, Magenta, Yellow, White, Varnish (800ml)  
Temperature: 5 °C to 35 °C  
Humidity: non condensing

·Cleaning cartridge (220 ml) (for both UH21 and US61 inks)  
Temperature: -10 °C to 50 °C (Storage up to one month maximum when stored between 40 °C to 50 °C )  
Humidity: 5% to 85% non condensing

<b>Power specification</b>	Input voltage	AC 100V to 240V ±10%
	Input frequency	50/60Hz ±1Hz
	Input load current	at least 12 A
<b>Power consumption</b>	Power off	AC100V to 120V: 2.1W or below AC200V to 240V: 3.2 W or below
	Sleep mode	44 W or below
	Ready-to-print	72 W or below
	Operation	1030 W or below
<b>Current consumption</b>	100V to 120V:	12 A or below
	200V to 240V:	6 A or below
<b>Dimensions</b>	Height	1,339 mm
	Width	2,770 mm
	Depth	1,459 mm
<b>Mass</b>	Printer	500 kg

Before Use

Setup

Various  
Settings

Basic  
Operations

Advanced  
Operations

Maintenance

When problems  
occur

Appendix

Specifications

Optional accessories /  
Consumable supplies

Revision history

# Optional accessories / Consumable supplies

For information about optional accessories and consumable supplies, please contact your local MUTOH dealer.

Before Use

Setup

Various Settings

Basic Operations

Advanced Operations

Maintenance

When problems occur

Appendix

Specifications

Optional accessories / Consumable supplies

Revision history

# Revision history

Date	Version	Manual	Supported Firmware
2023.6	00	XPJ1462UFE-A-00	V.1.00
2023.7	01	XPJ1462UFE-A-01	V.1.00
2023.11	02	XPJ1462UFE-A-02	V.1.04
2024.3	03	XPJ1462UFE-A-03	V.1.05
2024.11	04	XPJ1462UFE-A-04	V.1.08
2024.12	05	XPJ1462UFE-A-05	V.1.09
2025.7	06	XPJ1462UFE-A-06	V.1.10
2026.3	07	XPJ1462UFE-A-07	V.1.11 or later